

DOORS

GLAS
ITALIA

GLAS
ITALIA

ALADIN _ SHERAZADE

Design Piero Lissoni

- 5 Aladin Slide
- 39 Aladin Pocket
- 53 Aladin Pocket Frame
- 63 Aladin Swing Plain
- 87 Aladin Swing Frame
- 97 Aladin Pivot Plain Mono
- 103 Sherazade Swing Plain
- 109 Sherazade Swing Frame



ALADIN SLIDE

ALADIN SLIDE DUO

ALADIN SLIDE DUO . 7

/ Binario a 2 vie a soffitto in cartongesso
/ Finitura pannello: trasparente neutro
501. fumè
/ Finitura alluminio: 315. anodizzato inox S
/ Maniglie tonde senza supporto

/ Plasterboard ceiling rail with 2 ways
/ Panel finish: neutral transparent glass
501. fumé
/ Aluminium finish: 315. anodized inox S
/ Round handles without support

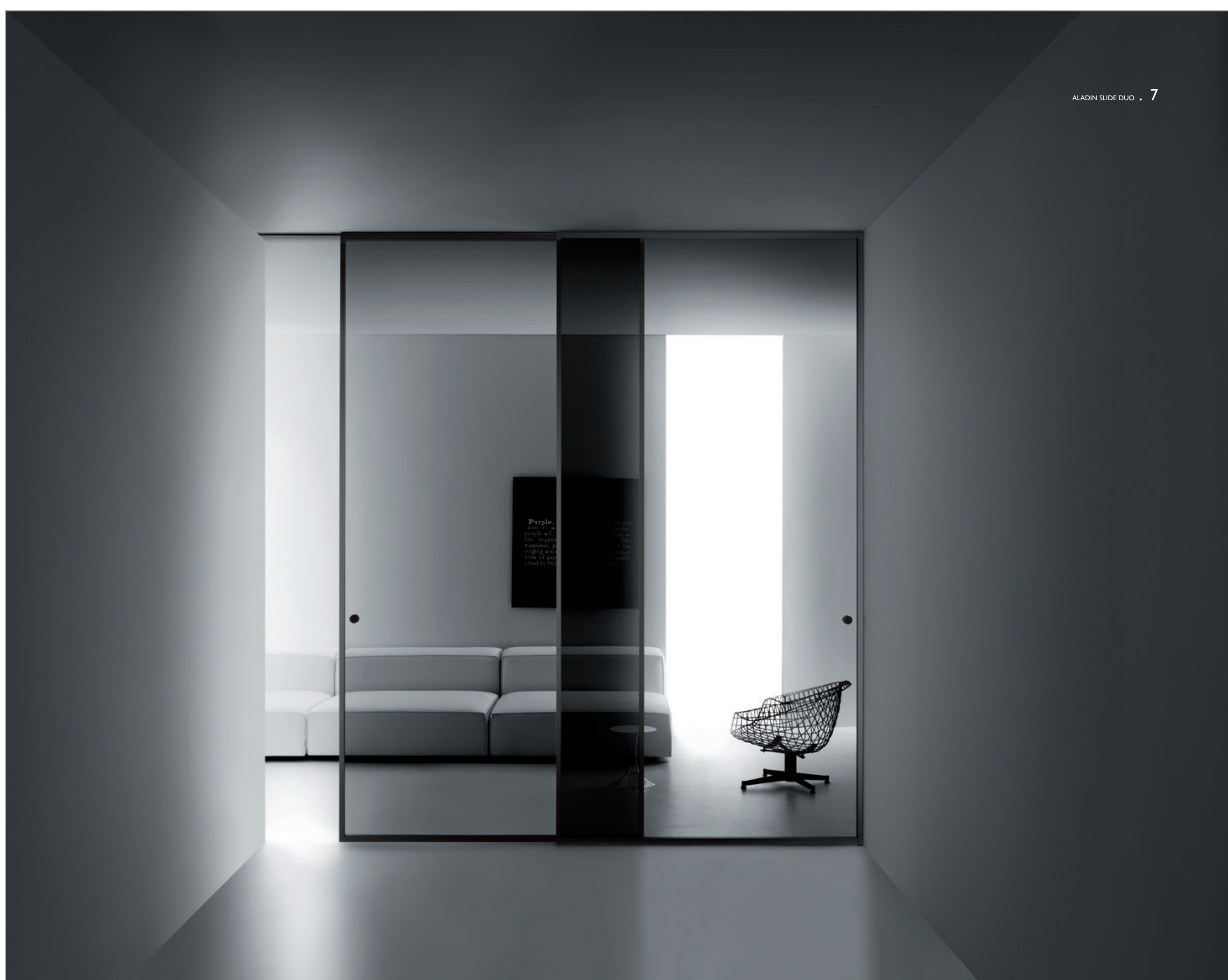



Purple. (F.-L.-Gk.) M. E. *purpure* (with *v.*) = O. F. *purpura*, later *purpura*; purple = L. *purpura*, the purple-fish = Gk. *porpura*, the purple-fish; cf. Gk. *porpura*, purple, sing. an eyelet of the seagull; see = Gk. *porpura*, substituted form of *porpura*, to mix up, stir violently, allied to Skt. root *dhru*, to be active.



Purple. (F.-L.-Gk.) M. E. *purpure* (with *v.*) = O. F. *purpura*, later *purpura*; purple = L. *purpura*, the purple-fish = Gk. *porpura*, the purple-fish; cf. Gk. *porpura*, purple, sing. an eyelet of the seagull; see = Gk. *porpura*, substituted form of *porpura*, to mix up, stir violently, allied to Skt. root *dhru*, to be active.

ALADIN SLIDE DUO

- / Binario a 2 vie a soffitto in cartongesso / Plasterboard ceiling rail with 2 ways
- / Finitura pannello: decoro "Life" 636. ramo / Panel finish: decoration "Life" 636. ramo
- / Finitura alluminio: 315. anodizzato inox S / Aluminium finish: 315. anodized inox S
- / Maniglie ovali senza supporto / Oval handles without support



12 . ALADIN SLIDE DUO

/ Maniglia ovale senza supporto

/ Oval handle without support





ALADIN SLIDE MONO

- / Binario a I via a parete lunghezza speciale
- / Finitura pannello: extralight con tessuto 551, raffaello
- / Finitura alluminio: 300, verniciato bianco Ral 9016
- / Maniglia tonda senza supporto
- / I way wall rail special length
- / Panel finish: extralight glass with fabric 551, raffaello
- / Aluminium finish: 300, verniciato bianco Ral 9016
- / Round handle without support





/ Maniglia ovale senza supporto

/ Oval handle without support





ALADIN SLIDE MONO

- / Binario a 1 via a parete
- / Finitura pannello: diffusore colorato opaco
132, ambra
- / Finitura alluminio: 300, verniciato bianco
Ral 9016
- / Maniglia tonda senza supporto
- / 1 way wall rail
- / Panel finish: opaque coloured diffusor
glass 132, ambra
- / Aluminium finish: 300, verniciato bianco
Ral 9016
- / Round handle without support



/ Profilo di battuta laterale per binario
a 1 via a parete

/ Side door striker for 1 way wall rail



- / Binario a 1 via a parete in cartongesso
- / Finitura pannello: acidato bifacciale cangiante 606.
- / Finitura alluminio: 314. anodizzato dark brown S
- / Maniglia ovale senza supporto
- / Plasterboard wall rail with 1 way
- / Panel finish: 606. acidato bifacciale cangiante
- / Aluminium finish: 314. anodized dark brown S
- / Oval handle without support





ALADIN SLIDE MONO

- / Binario a 2 vie sospeso
- / Finitura pannelli (da sx verso dx):
605. acidato bifacciale bronzo,
diffusore colorato lucido 155. neve,
extralight con rete 531. wide,
trasparente neutro 501. fumé,
604. acidato bifacciale fumé
- / Finitura alluminio: 314 anodizzato
dark brown S
- / Maniglie tonde senza supporto
- / 2 ways hanging rail
- / Panel finish (from left to right):
double faced acid-etched glass
605. acidato bifacciale bronzo,
glossy coloured diffusor glass 155. neve,
extralight glass with mesh 531. wide,
neutral transparent glass 501. fumé,
double faced acid-etched glass
604. acidato bifacciale fumé,
- / Aluminium finish: 314. anodized
dark brown S
- / Round handles without support



/ Cristallo extralight con rete 531.
wide bronze
/ Binario a 2 vie sospeso

/ Extralight glass with mesh 531.
wide bronze
/ 2 ways hanging rail

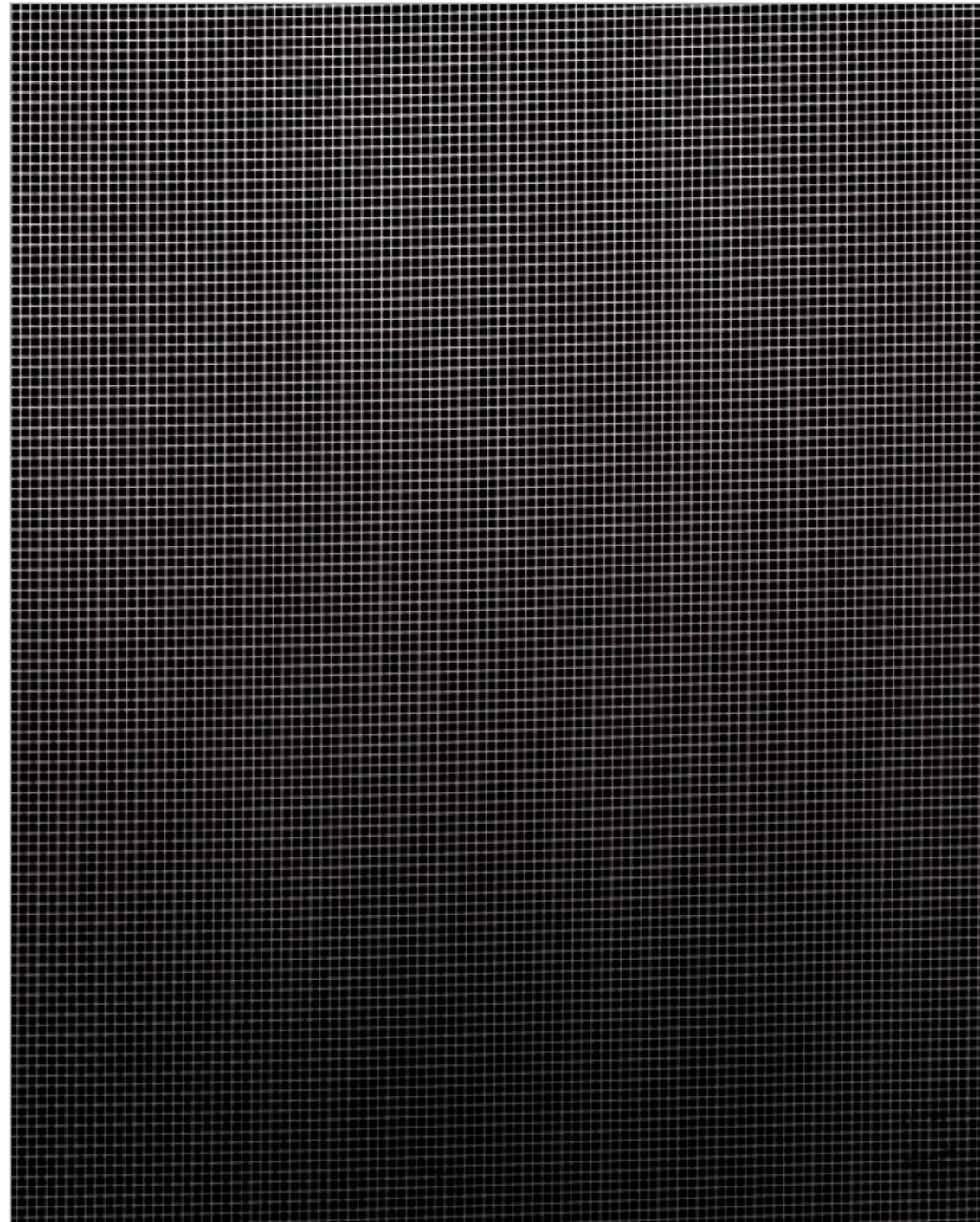

- / Binario a 2 vie a soffitto in cartongesso
- / Finitura alluminio: 314, anodizzato dark brown S
- / Plasterboard ceiling rail with 2 ways
- / Aluminium finish: 314, anodized dark brown S
- / Binario a 1 via a soffitto in cartongesso
- / Finitura alluminio: 314, anodizzato dark brown S
- / Plasterboard ceiling rail with 1 way
- / Aluminium finish: 314, anodized dark brown S



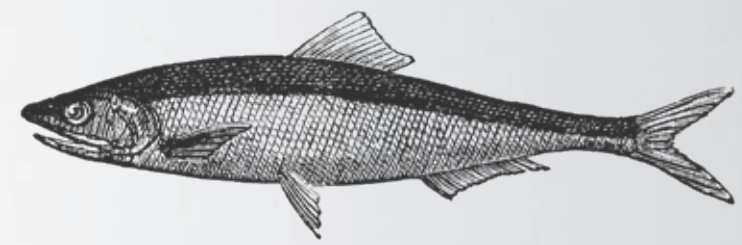

ALADIN POCKET

ALADIN POCKET DUO

DOPPIA ANTA / DOUBLE DOOR

- / Finitura pannello: stampato trasparente
520. flutes
- / Finitura alluminio: 314 anodizzato
dark brown S
- / Maniglia doppia con nottolino

- / Panel finish: transparent patterned glass
520. flutes
- / Aluminium finish: 314. anodized
dark brown S
- / Double handle with revolving plug





/ Vetro 520. flutes

/ Glass 520. flutes



ALADIN POCKET DUO

DOPPIA ANTA / DOUBLE DOOR

- / Finitura pannello: 601. acidato monofacciale fumé
- / Finitura alluminio: 314 anodizzato dark brown S
- / Maniglia doppia con nottolino
- / Panel finish: single faced acid-etched glass 601. acidato monofacciale fumé
- / Aluminium finish: 314. anodized dark brown S
- / Double handle with revolving plug

ALADIN POCKET DUO . 47





ALADIN POCKET DUO

/ Finitura pannello: 505, riflettente fumé / Panel finish: 505, riflettente fumé
/ Finitura alluminio: 315 anodizzato inox S / Aluminium finish: 315, anodized inox S
/ Maniglia tonda senza supporto / Round handle without support



ALADIN POCKET DUO . 51





ALADIN POCKET FRAME

ALADIN POCKET FRAME MONO

- / Finitura pannello: extralight con tessuto 553, botticelli
- / Finitura alluminio: 300, verniciato bianco Ral 9016
- / Maniglia con nottolino
- / Panel finish: extralight glass with fabric 553, botticelli
- / Aluminium finish: 300, verniciato bianco Ral 9016
- / Handle with revolving plug



/ Dettaglio stipite / Jamb detail
/ Cristallo extralight con tessuto 553, botticelli / Extralight glass with fabric 553, botticelli
/ Maniglia con nottolino / Handle with revolving plug



ALADIN POCKET FRAME MONO

- / Finitura pannello: trasparente colorato
103. verde
- / Finitura alluminio: 300. verniciato bianco
Ral 9016
- / Maniglia con nottolino

- / Panel finish: coloured transparent glass
103. verde
- / Aluminium finish: 300. verniciato bianco
Ral 9016
- / Handle with revolving plug







ALADIN SWING PLAIN

ALADIN SWING PLAIN DUO

- / Finitura pannello: extralight sfumato
620. bianco
- / Finitura alluminio: 300. verniciato bianco
Ral 9016
- / Maniglia senza blocco

- / Panel finish: shaded extralight glass
620. bianco
- / Aluminium finish: 300. verniciato bianco
Ral 9016
- / Handle without block

ALADIN SWING PLAIN DUO . 65



/ Maniglia senza blocco

/ Handle without block



ALADIN SWING PLAIN MONO

- / Finitura pannello: 500, extralight
- / Finitura alluminio: 315, anodizzato inox S
- / Maniglia senza blocco
- / Panel finish: 500, extralight
- / Aluminium finish: 315, anodized inox S
- / Handle without block



/ Finitura pannello: extralight con tessuto
552. masaccio
/ Finitura alluminio: 314. anodizzato
dark brown S
/ Maniglia con chiusura privacy

/ Panel finish: extralight glass with fabric
552. masaccio
/ Aluminium finish: 314. anodized
dark brown S
/ Handle with privacy lock



/ Cristallo extralight con tessuto 552.
masaccio
/ Maniglia con chiusura privacy

/ Extralight glass with fabric 552. masaccio
/ Handle with privacy lock





- | | |
|---|--|
| / Finitura pannello: trasparente colorato
95, blu chiaro | / Panel finish: transparent coloured
95, blu chiaro |
| / Finitura alluminio: 300, verniciato bianco
Ral 9016 | / Aluminium finish: 300, verniciato bianco
Ral 9016 |
| / Pomolo senza blocco | / Knob without block |



ALADIN SWING PLAIN MONO / DUO

ALADIN SWING PLAIN MONO / DUO . 79

- / Finitura pannello: laccato opaco 70, bianco
- / Finitura alluminio: 300, verniciato bianco
Ral 9016
- / Pomolo con chiave e pomolo senza blocco
- / Panel finish: matt lacquered glass 70, bianco
- / Aluminium finish: 300, verniciato bianco
Ral 9016
- / Knob with key lock and knob without block



/ Pomolo senza blocco

/ Knob without block





/ Pomolo senza blocco

/ Knob without block



ALADIN SWING FRAME



ALADIN SWING FRAME DUO

/ Finitura pannello: laccato opaco
107, nocciola
/ Finitura alluminio: 315, anodizzato inox S
/ Maniglia con chiave

/ Panel finish: matt lacquered glass
107, nocciola
/ Aluminium finish: 315, anodized inox S
/ Handle with key lock

ALADIN SWING FRAME DUO . 89



/ Dettaglio stipite

/ Jamb detail



ALADIN SWING FRAME DUO

ALADIN SWING FRAME DUO . 93

- / Finitura pannello: 600, acidato
monofacciale extralight
- / Finitura alluminio: 300, verniciato bianco
Ral 9016
- / Maniglia senza blocco

- / Panel finish: 600, acidato
monofacciale extralight
- / Aluminium finish: 300, verniciato bianco
Ral 9016
- / Handle without block



/ Finitura pannello: 600, acidato
monofacciale extralight
/ Maniglia senza blocco

/ Panel finish: 600, acidato
monofacciale extralight
/ Handle without block





ALADIN PIVOT PLAIN MONO

/ Finitura pannello: Carta di riso opaca 555. / Panel finish: Carta di riso opaca 555.
/ Finitura alluminio: 300, verniciato Bianco Ral 9016 / Aluminium finish: 300, verniciato Bianco Ral 9016
/ Maniglia senza blocco / Handle without block





SHERAZADE

SHERAZADE

SHERAZADE

SHERAZADE

SHERAZADE

SHERAZADE

SHERAZADE

SHERAZADE

SHERAZADE SWING PLAIN

/ Finitura pannello: 557, pura seta grigio
/ Finitura alluminio: 313, anodizzato
bronzo S
/ Maniglia con nottolino

/ Panel finish: 557, pura seta grigio
/ Aluminium finish: 313, anodized
bronze S
/ Handle with revolving plug







SHERAZADE SWING FRAME

/ Finitura pannello: 556.pura seta crema
/ Finitura alluminio: 314. anodizzato
dark brown S
/ Maniglia con cilindro

/ Panel finish: 556.pura seta crema
/ Aluminium finish: 314. anodized
dark brown S
/ Handle with cylinder lock







DISEGNI TECNICI + FINITURE

SLIDING SYSTEM

Il sistema scorrevole è composto da un binario regolabile a una o più vie, contenuto in una trave d'alluminio con fissaggio a parete o a soffitto, incassata nel cartongesso o sospesa.

Le ante, prodotte nella versione mono lastra **Aladin Slide Mono**, **Sherazade Slide** o doppia lastra **Aladin Slide Duo**, con telaio d'alluminio disponibile in quattro finiture, vengono appese al binario per mezzo di carrelli con scorrimento fluido e silenzioso.

La chiusura delle ante, grazie a dei rallentatori posti a fine corsa, risulta essere molto dolce e precisa.

Le ante possono anche essere bloccate e utilizzate come pannellature divisorie fisse; è inoltre possibile montare maniglie con o senza serratura e profili di battuta di diverse tipologie.

Il sistema non ha guida a terra.

The sliding system is composed by an adjustable one-way or more-ways rail, contained in an aluminium beam, fixed whether on the wall or on the ceiling, recessed into the drywall or hanging. Beam and rail are supplied custom-cut.

The doors, produced in the single panel version **Aladin Slide Mono**, **Sherazade Slide** or double panel **Aladin Slide Duo**, with aluminium frame available in four different aluminium finishing, are hanged on the rail thanks to carriages with fluid and silent sliding.

The closing of the doors, thanks to a soft motion placed at the end of the rail, is very soft and precise. Doors can be also blocked and used as fixed wall partitions. It is possible to assemble different handles with or without lock and different kinds of door-strikers profiles.

The system has no guiding tracks.

BINARIO A 2 VIE / 2 WAYS RAIL

Binario a parete /
Wall rail

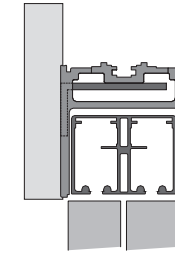

Binario a parete cartongesso /
Wall rail in plasterboard

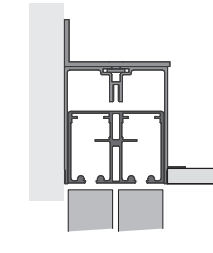

Binario a soffitto /
Ceiling rail

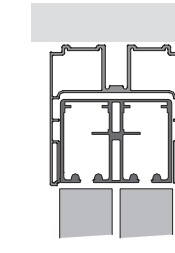

Binario a soffitto in cartongesso /
Ceiling rail in plasterboard

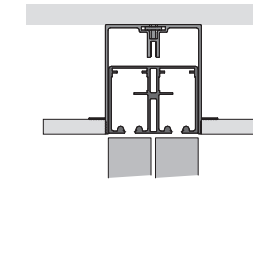
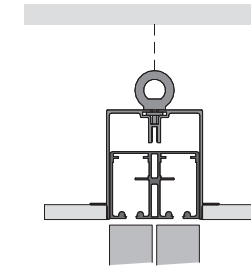

Binario sospeso /
Hanging rail

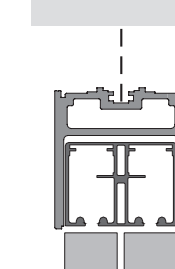

BINARIO A 1 VIA / 1 WAY RAIL

Binario a parete /
Wall rail



Binario a parete cartongesso /
Wall rail in plasterboard

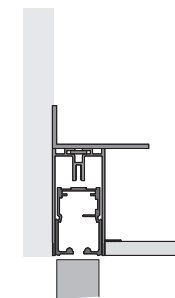

Binario a soffitto /
Ceiling rail

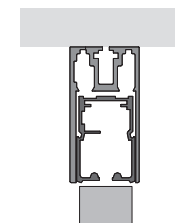

Binario a soffitto in cartongesso /
Ceiling rail in plasterboard

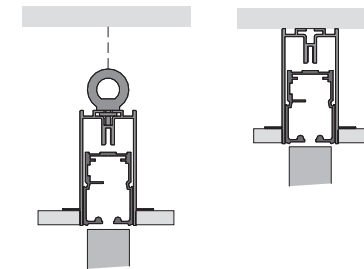

BINARIO A 3 VIE / 3 WAYS RAIL

Binario a soffitto /
Ceiling rail

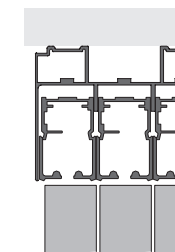

Binario a soffitto in cartongesso /
Ceiling rail in plasterboard

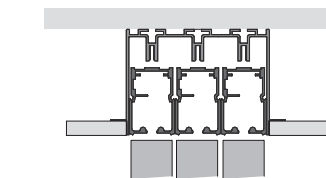
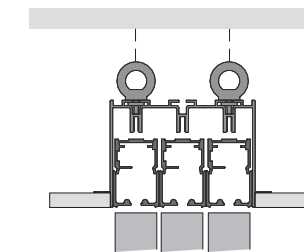

ALADIN SLIDE MONO

I pannelli **Aladin Slide Mono** hanno un vetro applicato su un lato del telaio, in modo da avere una faccia con superficie planare e l'altra con superficie arretrata rispetto alla cornice perimetrale d'alluminio.

Il vetro, disponibile in una vastissima gamma di finiture, può essere monolitico temperato 6 mm oppure stratificato 3 + 3 mm.

Tutti i vetri sono certificati secondo le normative di sicurezza ANSI Z97.1 e UNI EN12150.

Sono disponibili anche pannelli in gres o in diverse finiture.

The **Aladin Slide Mono** panels have a glass applied on one side of the frame so that one side has a flush surface and the other is rebated from the aluminium frame.

The glass, available in a wide range of finishes, can be monolithic tempered 6 mm in a single piece or laminated 3 + 3 mm.

The glass is certified according to the safety regulation ANSI Z97.1 and UNI EN12150.

Panels in stoneware with different finishes are available too.

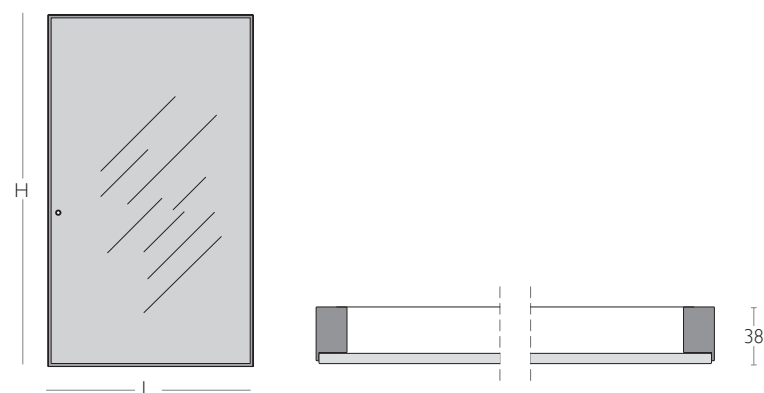

codice
code
ASLM

ALADIN SLIDE DUO

I pannelli **Aladin Slide Duo** hanno vetri temperati spessore 4 mm, applicati su entrambe le facce del telaio, in modo da formare un volume con una camera d'aria interna.

I vetri, disponibili in un'ampia gamma di finiture, sono certificati secondo le normative di sicurezza ANSI Z97.1 e UNI EN12150.

Sono disponibili anche pannelli in gres o in legno, con diverse finiture ed essenze.

The **Aladin Slide Duo** panels, have 4 mm thick tempered glass applied on both faces of the frame, so as to form a volume with an internal air chamber.

The glass is available in a wide range of finishes and it is certified according to the safety regulation ANSI Z97.1 and UNI EN12150.

Panels in stoneware and in wood with different finishes and essences are available too.

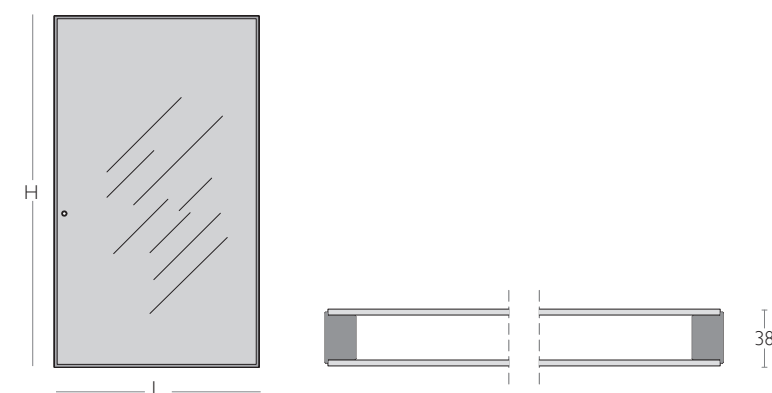

codice
code
ASLD

**MANIGLIE ALADIN SLIDE /
ALADIN SLIDE HANDLES**

Maniglia tonda senza supporto /
Round handle without support

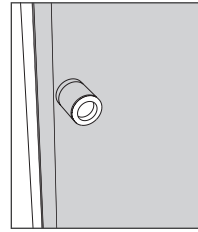

codice
code
MSS

Maniglia con supporto /
Handle with support

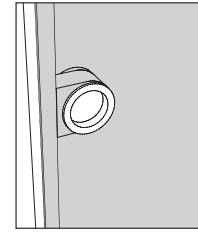

codice
code
MCS

Maniglia con nottolino /
Handle with revolving plug

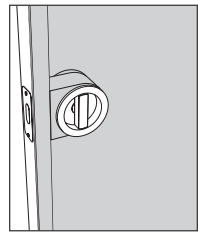

codice
code
MCN

Maniglia ovale senza supporto /
Oval handle without support

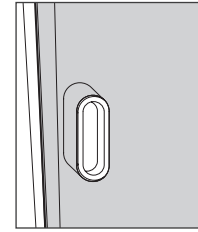

codice
code
MSO

**ACCESSORI ALADIN SLIDE /
ALADIN SLIDE ACCESSORIES**

Profilo di battuta frontale / Front door striker profile
Versione binari a soffitto, a soffitto - cartongesso,
con trave sospesa.
Ceiling, plasterboard ceiling and hanging rail version.

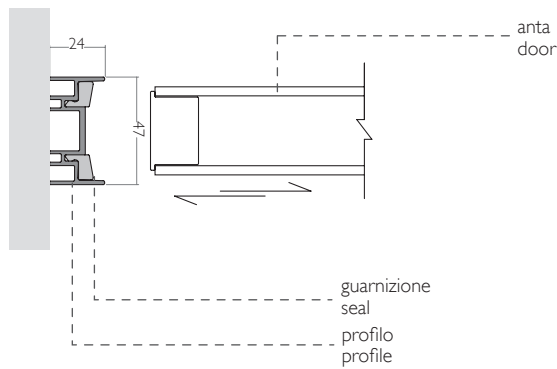

Profilo di battuta laterale / Side door striker profile
Versione binari a parete 1 via.
1 wall rail version.

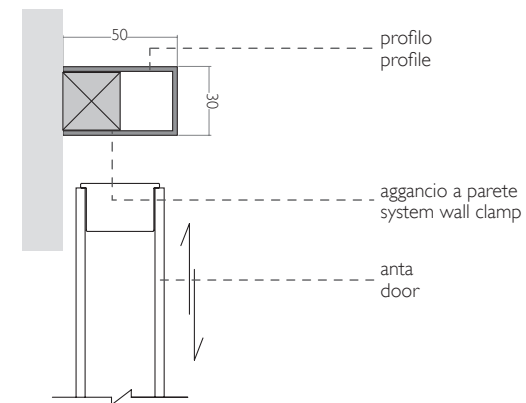

Profilo di battuta laterale / Side door striker profile
Versione binari a parete 2 vie.
2 ways wall rail version.

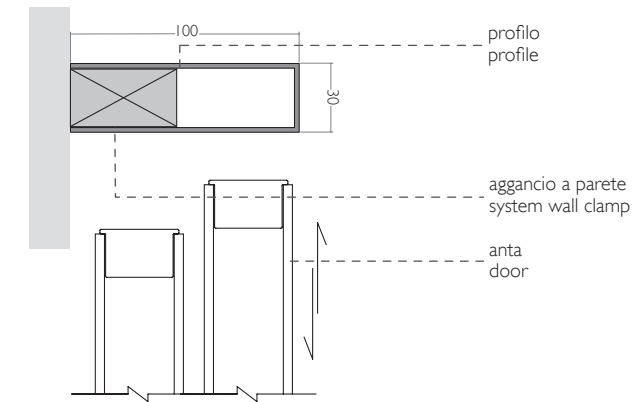

Profilo di battuta per serratura / Door striker profile for lock
Versione binari a soffitto, a soffitto - cartongesso, con trave sospesa.
Ceiling, plasterboard ceiling and hanging rail version.

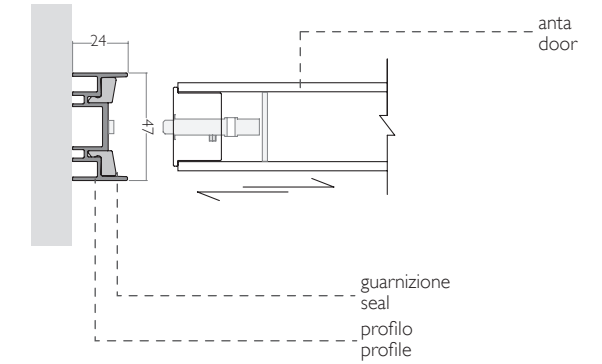

Profilo di battuta laterale per serratura / Side door striker profile for lock
Versione binari a parete 1 via.
1 wall rail version.

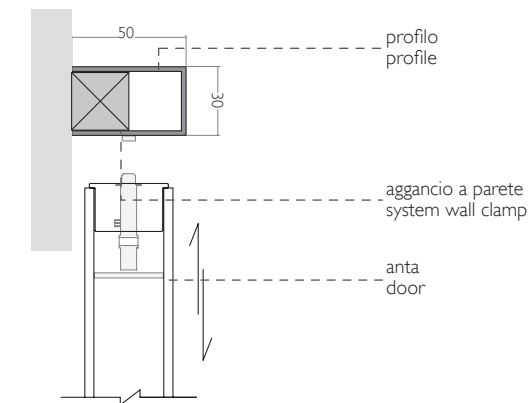

ALADIN POCKET MONO

Le ante **Aladin Pocket Mono**, prodotte su misura e perfettamente integrabili nei più diffusi sistemi di porte scorrevoli a scomparsa senza stipite, quali Scrigno Essential® scorrevole ed Eclisse® Syntesis Line, hanno un vetro applicato su un lato del telaio, in modo da avere una faccia con superficie planare e l'altra con superficie arretrata rispetto alla cornice perimetrale d'alluminio. Il vetro, disponibile in una vastissima gamma di finiture, può essere monolitico temperato 6 mm oppure stratificato 3 + 3 mm. Tutti i vetri sono certificati secondo le normative di sicurezza ANSI Z97.1 e UNI EN12150. Sono disponibili anche pannelli in gres con diverse finiture. Le due versioni, ad anta singola e ad anta doppia, possono essere fornite con o senza serratura. A richiesta vengono forniti anche i controtelai per cartongesso e intonaco.

The **Aladin Pocket Mono** doors are custom-made, can be integrated into the most common systems of frameless sliding pocket doors such as Scrigno Essential® sliding and Eclisse® Syntesis Line and have glass applied on one side of the frame so that one side has a flush surface and the other is rebated from the aluminium frame. The glass, available in a wide range of finishes, can be monolithic tempered 6 mm as a single piece or laminated 3 + 3 mm. The glass is certified according to the safety regulation ANSI Z97.1 and UNI EN12150. Panels in stoneware with different finishes are available too. The two versions, with single or double door, can be supplied with or without the lock. Subframes for plasterboard or brick walls can be provided on demand.

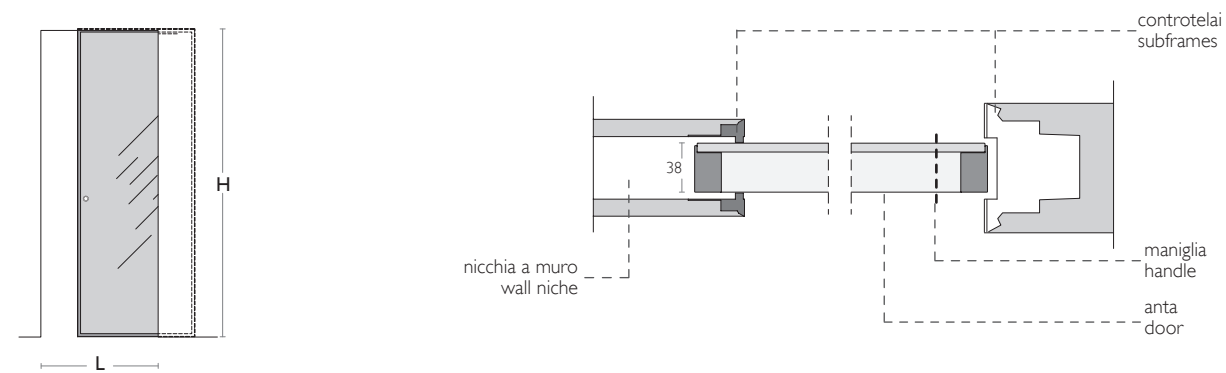

codice
code
APO1M

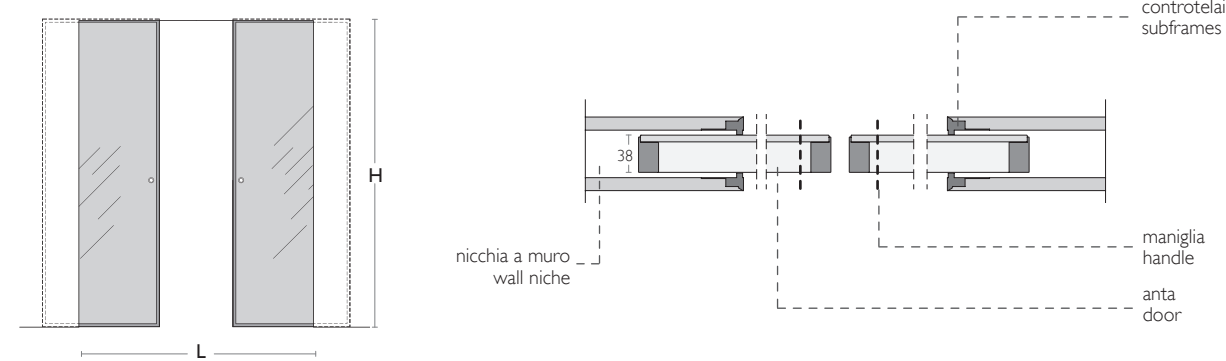

codice
code
APO2M

ALADIN POCKET DUO

Le ante **Aladin Pocket Duo**, prodotte su misura e perfettamente integrabili nei più diffusi sistemi di porte scorrevoli a scomparsa senza stipite, quali Scrigno Essential® scorrevole ed Eclisse® Syntesis Line, hanno vetri temperati spessore 4 mm applicati su entrambe le facce del telaio, in modo da formare un volume con una camera d'aria interna. I vetri, disponibili in un'ampia gamma di finiture, sono certificati secondo le normative di sicurezza ANSI Z97.1 e UNI EN12150. Sono disponibili anche pannelli in gres o in legno, con diverse finiture ed essenze. Le due versioni, ad anta singola e ad anta doppia, possono essere fornite con o senza serratura. A richiesta vengono forniti anche i controtelai per cartongesso e intonaco.

The **Aladin Pocket Duo** doors are custom-made, can be integrated into the most common systems of frameless sliding pocket doors such as Scrigno Essential® sliding and Eclisse® Syntesis Line and have 4 mm thick tempered glass applied on both faces of the frame, so as to form a volume with an internal air chamber. The glass is available in a wide range of finishes and it is certified according to the safety regulation ANSI Z97.1 and UNI EN12150. Panels in stoneware and in wood with different finishes and essences are available too. The two versions, with single or double door, can be supplied with or without the lock. Subframes for plasterboard or brick walls can be provided on demand.

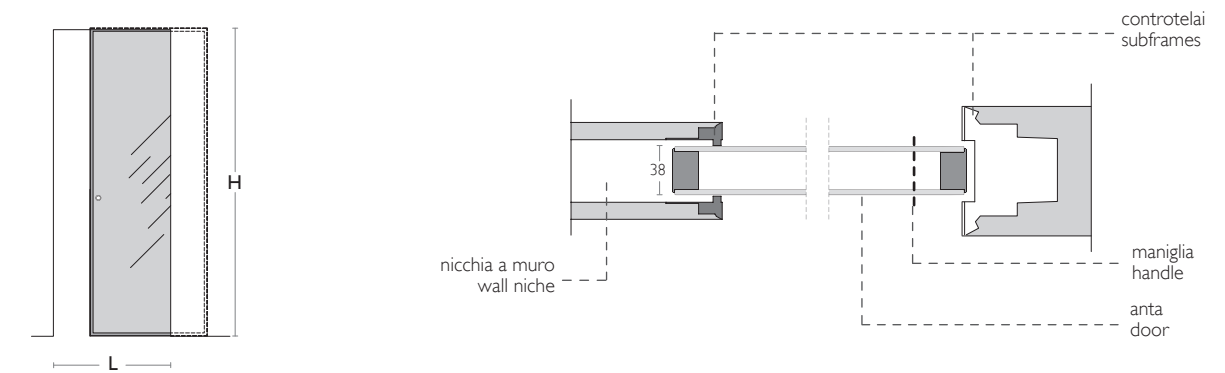

codice
code
APO1D

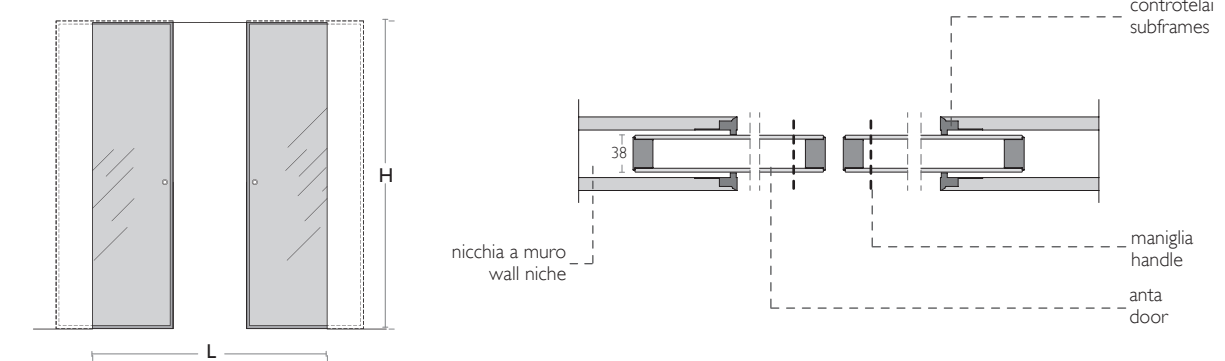

codice
code
APO2D

MANIGLIE ALADIN POCKET ANTA SINGOLA / ALADIN POCKET SINGLE DOOR HANDLES

Maniglia tonda senza supporto / Round handle without support

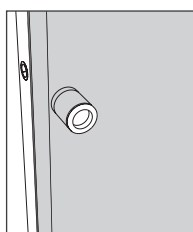

codice code
MSS

Maniglia con supporto / Handle with support

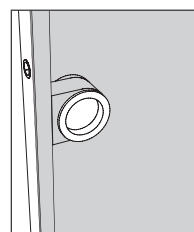

codice code
MCS

Maniglia con nottolino / Handle with revolving plug

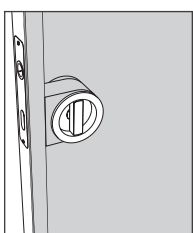

codice code
MCN

Maniglia ovale senza supporto / Oval handle without support

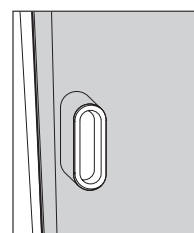

codice code
MSO

MANIGLIE ALADIN POCKET ANTA DOPPIA / ALADIN POCKET DOUBLE DOOR HANDLES

Maniglia tonda doppia senza supporto / Double round handle without support

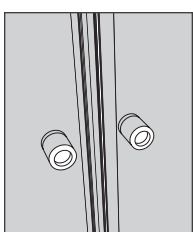

codice code
M2SS

Maniglia doppia con supporto / Double handle with support

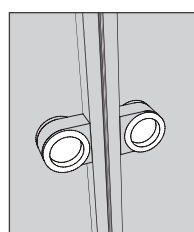

codice code
M2CS

Maniglia doppia con nottolino / Double handle with revolving plug

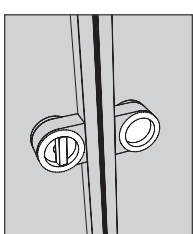

codice code
M2CN

Maniglia ovale doppia senza supporto / Double oval handle without support

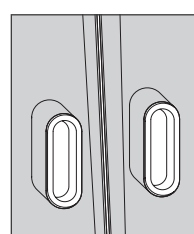

codice code
M2SO

ALADIN POCKET FRAME MONO

Le ante **Aladin Pocket Frame Mono**, prodotte su misura e perfettamente integrabili nei più diffusi sistemi di porte scorrevoli a scomparsa, hanno un vetro applicato su un lato del telaio, in modo da avere una faccia con superficie planare e l'altra con superficie arretrata rispetto alla cornice perimetrale d'alluminio. Il vetro, disponibile in una vastissima gamma di finiture, può essere monolitico temperato 6 mm oppure stratificato 3 + 3 mm.

Tutti i vetri sono certificati secondo le normative di sicurezza ANSI Z97.1 e UNI EN 12150. Sono disponibili anche pannelli in gres con diverse finiture.

La porta viene fornita completa di stipite telescopico in alluminio, con dimensioni standard da 90 a 130 mm, nella stessa finitura del telaio dell'anta.

Per dimensioni maggiori devono essere considerati gli extra prezzi indicati. Le due versioni, ad anta singola e ad anta doppia, possono essere fornite con o senza serratura.

A richiesta vengono forniti anche i controtelai per cartongesso e intonaco.

The **Aladin Pocket Frame Mono** doors are custom-made, can be integrated into the most common systems of sliding pocket doors and have a glass applied on one side of the frame so that one side has a flush surface whilst the other is rebated from the aluminium frame. The glass, available in a wide range of finishes, can be monolithic tempered 6 mm as a single piece or laminated 3 + 3 mm. The glass is certified according to the safety regulation ANSI Z97.1 and UNI EN 12150.

Panels in stoneware with different finishes are available, too.

The door is supplied with telescopic aluminium jambs, from 90 up to 130 mm, in the same finish as the door frame.

For larger dimensions, additional costs as specified must be taken into consideration.

The two versions, with single or double door, can be provided with or without lock. Subframes for plasterboard or brick walls can be provided on demand.

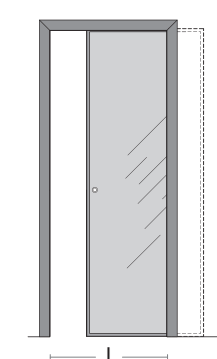

codice code
APOFIM

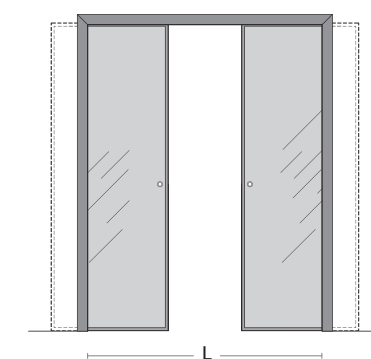

codice code
APOF2M

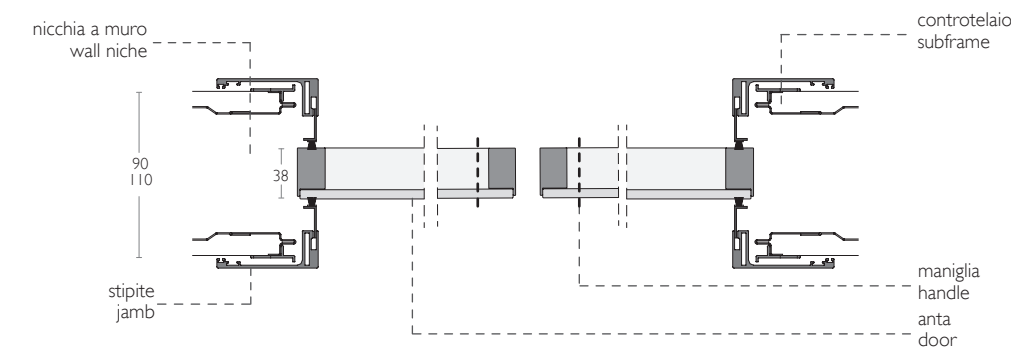
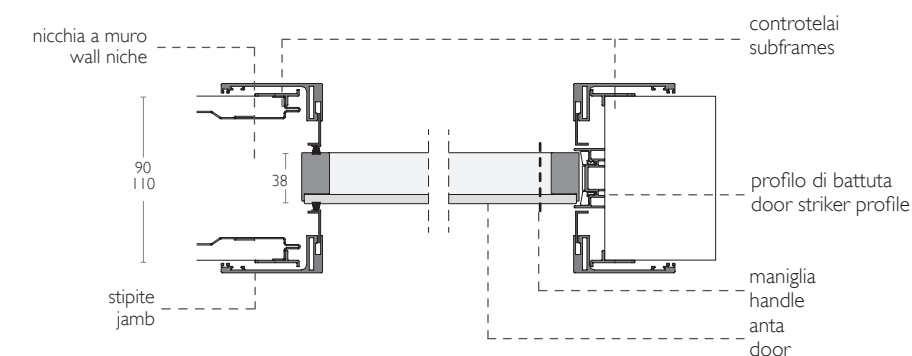

ALADIN POCKET FRAME DUO

Le ante **Aladin Pocket Frame Duo**, prodotte su misura e perfettamente integrabili nei più diffusi sistemi di porte scorrevoli a scomparsa, hanno vetri temperati spessore 4 mm applicati su entrambe le facce del telaio d'alluminio, disponibile in quattro diverse finiture, in modo da formare un volume con una camera d'aria interna. La porta viene fornita completa di stipite telescopico in alluminio con dimensioni standard da 90 a 130 mm nella stessa finitura del telaio dell'anta. Per dimensioni maggiori devono essere considerati gli extra prezzi indicati. I vetri, disponibili in un'ampia gamma di finiture, sono certificati secondo le normative di sicurezza ANSI Z97.1 e UNI EN 12150. Sono disponibili anche pannelli in gres o in legno, con diverse finiture ed essenze. Le due versioni, ad anta singola e ad anta doppia, possono essere fornite con o senza serratura. A richiesta vengono forniti anche i controtelai per cartongesso e intonaco.

The **Aladin Pocket Frame Duo** doors are custom-made, can be integrated into the most common pocket systems of sliding pocket doors and have 4 mm thick tempered glass applied on both faces of the aluminium frame, available in four different finishes, so as to form a volume with an internal air chamber. The door is supplied with telescopic aluminium jambs, from 90 up to 130 mm, in the same finish as the door frame. For larger dimensions, additional costs as specified must be taken into consideration. The glass is available in a wide range of finishes and it is certified according to the safety regulation ANSI Z97.1 and UNI EN 12150. Panels in stoneware and in wood with different finishes and essences are available too. The two versions, with single or double door, can be provided with or without lock. Subframes for plasterboard or brick walls can be provided on demand.

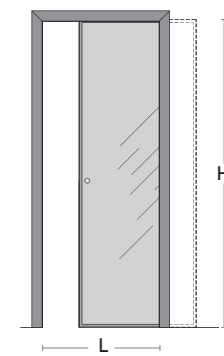

codice
code
APOF1D

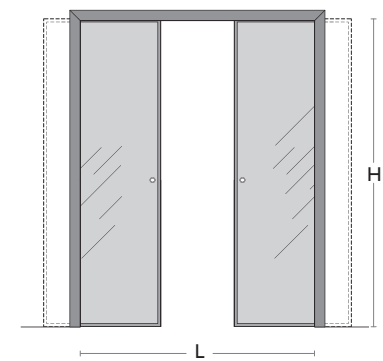

codice
code
APOF2D

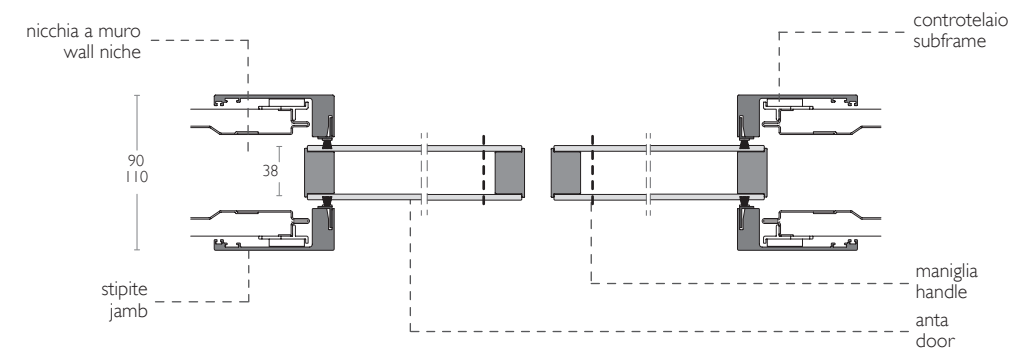
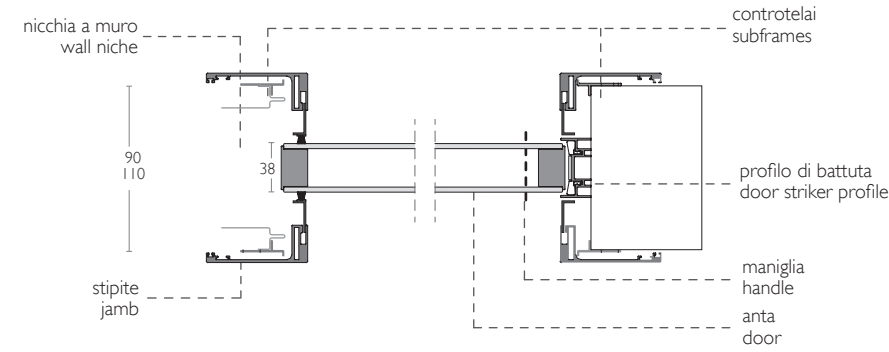

MANIGLIE ALADIN POCKET FRAME ANTA SINGOLA / ALADIN POCKET FRAME SINGLE DOOR HANDLES

Maniglia tonda senza supporto / Round handle without support

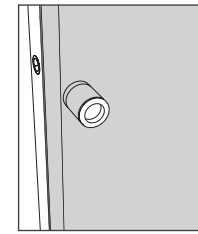

codice
code
MSS

Maniglia con supporto / Handle with support

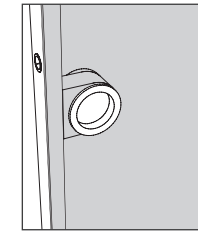

codice
code
MCS

Maniglia con nottolino / Handle with revolving plug

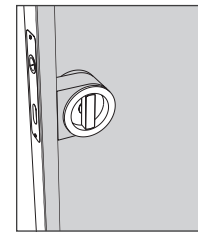

codice
code
MCN

Maniglia ovale senza supporto / Oval handle without support

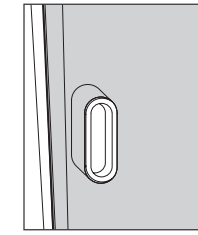

codice
code
MCO

MANIGLIE ALADIN POCKET FRAME ANTA DOPPIA / ALADIN POCKET FRAME DOUBLE DOOR HANDLES

Maniglia tonda doppia senza supporto / Double round handle without support

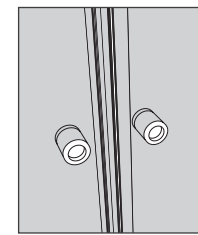

codice
code
M2SS

Maniglia doppia con supporto / Double handle with support

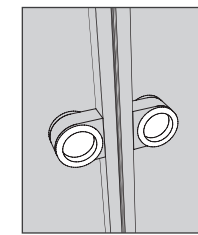

codice
code
M2CS

Maniglia doppia con nottolino / Double handle with revolving plug

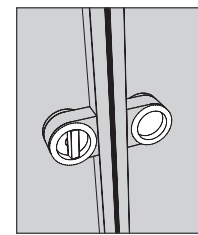

codice
code
M2CN

Maniglia doppia ovale senza supporto / Double oval handle without support

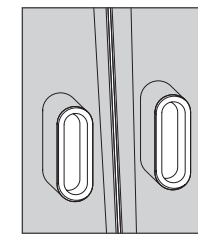

codice
code
M2SO

ALADIN SWING PLAIN MONO

Aladin Swing Plain Mono è una porta a battente raso muro prodotta su misura, con cerniere a perno regolabili. Un vetro è applicato su un lato di un telaio in alluminio, disponibile in quattro finiture, in modo da avere una faccia con superficie planare e l'altra con superficie ametrata rispetto alla cornice perimetrale. Il vetro può essere monolitico temperato 6 mm oppure stratificato 3 + 3 mm temperato, disponibile in una vastissima gamma di finiture. Tutti i vetri sono certificati secondo le normative di sicurezza ANSI Z97.1 e UNI EN12150. Sono disponibili anche pannelli in gres con diverse finiture. È possibile montare diversi tipi di serrature e scegliere tra maniglia o pomolo, nella stessa finitura del telaio. Il controtelaio in alluminio decapato, invisibile quando la porta è chiusa, è disponibile sia per pareti cementizie sia in cartongesso e può essere verniciato direttamente con la pitturazione delle pareti. Disponibile anche nella versione filo soffitto.

Aladin Swing Plain Mono is a custom-made swing door with concealed frame and adjustable pivot hinges. A glass is applied on one side of an aluminium frame, available in four different finishes, so as to have a face with a flush surface, and another surface rebated from the perimeter aluminium frame. The glass can be monolithic tempered 6 mm in a single piece or tempered laminated 3 + 3 mm available in a wide range of different finishes. The glass is certified according to the safety regulation ANSI Z97.1 and UNI EN12150. Panels in stoneware with different finishes are available, too. It is possible to assemble different kind of locks and choose between handle and knob, which are provided in the same finishes as the frame. The pickled aluminium subframe, invisible when the door is closed, is available for both cement walls and plasterboard and can be varnished during the painting of the walls. Available also in the version with frame flush with the ceiling.

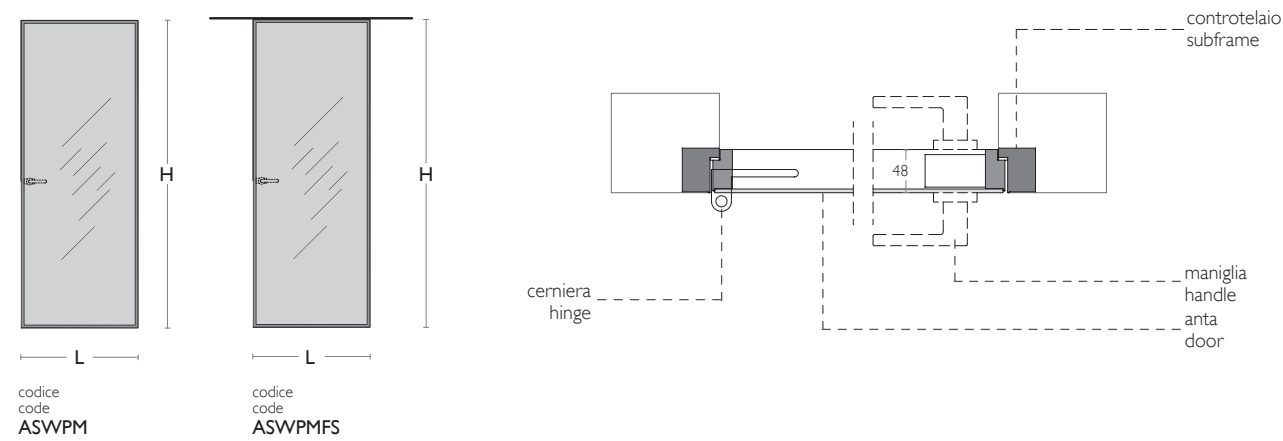

IPOTESI PROGETTUALI / PROJECT CONFIGURATIONS

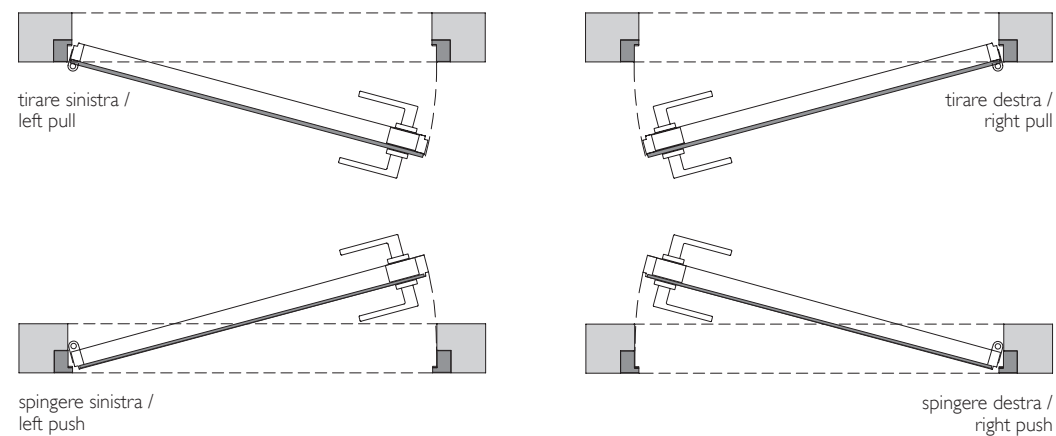

ALADIN SWING PLAIN DUO

Aladin Swing Plain Duo è una porta a battente raso muro prodotta su misura, con cerniere a perno regolabili. Dei vetri temperati spessore 4 mm sono applicati su entrambe le facce di un telaio in alluminio, disponibile in quattro finiture, in modo da formare un volume con una camera d'aria interna. I vetri, disponibili in un'ampia gamma di finiture, sono certificati secondo le normative di sicurezza ANSI Z97.1 e UNI EN12150. Sono disponibili anche pannelli in gres o in legno, con diverse finiture ed essenze. È possibile montare diversi tipi di serrature e scegliere tra maniglia o pomolo nella stessa finitura del telaio. Il controtelaio in alluminio decapato, invisibile quando la porta è chiusa, è disponibile sia per pareti cementizie sia in cartongesso e può essere verniciato direttamente con la pitturazione delle pareti. Disponibile anche nella versione filo soffitto.

Aladin Swing Plain Duo is a custom-made swing door with a concealed frame and with adjustable pivot hinges. The 4 mm thick tempered glass is applied on both faces of an aluminium frame, available in four different finishes, so as to form a volume with an internal air chamber. The glass is available in a wide range of finishes and it is certified according to the safety regulation ANSI Z97.1 and UNI EN12150. Panels in stoneware and in wood with different finishes and essences are available too. It is possible to assemble different locks and choose either between handle and knob in the same finish as the frame. The pickled aluminium subframe, invisible when the door is closed, is available for both cement walls and plasterboard and can be varnished during the painting of the walls. Available also in the version with frame flush with the ceiling.

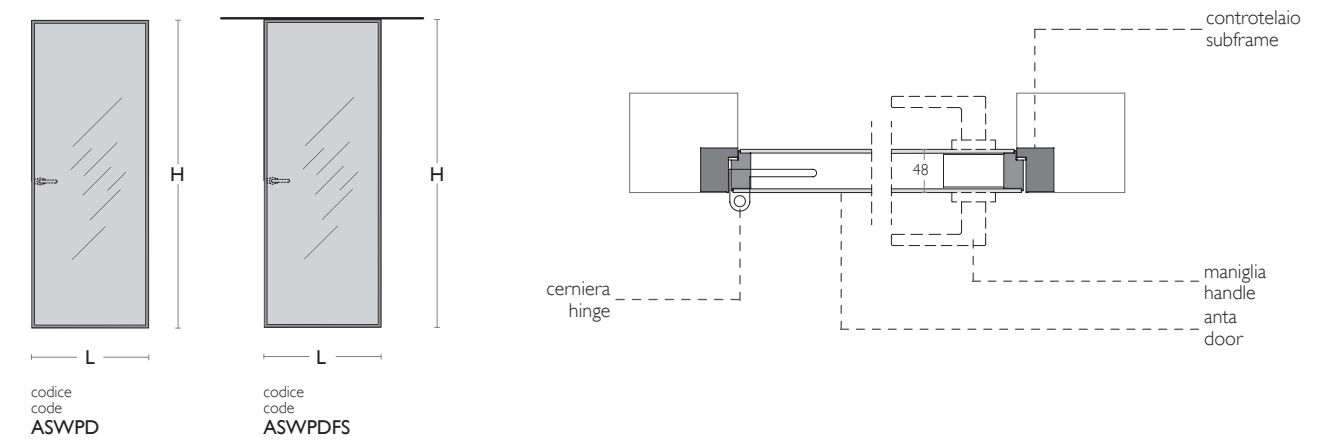

IPOTESI PROGETTUALI / PROJECT CONFIGURATIONS

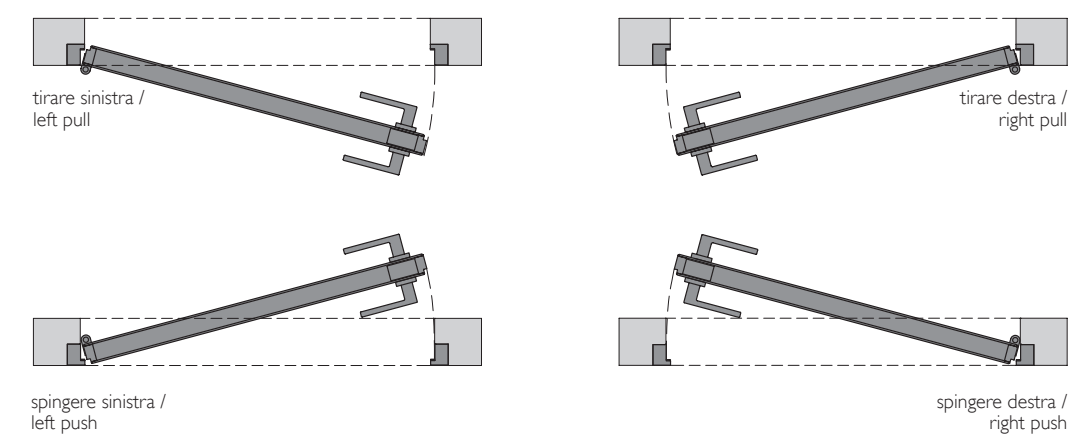

**MANIGLIE ALADIN SWING PLAIN MONO /
ALADIN SWING PLAIN MONO HANDLES**

Maniglia senza blocco /
Handle without block

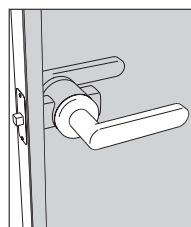

codice
code
LSB

Maniglia con chiusura privacy /
Handle with privacy lock



codice
code
LCP

Maniglia con chiave /
Handle with key lock

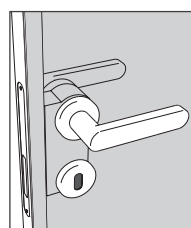

codice
code
LCC

Maniglia con cilindro /
Handle with cylinder lock



codice
code
LCY

**POMOLI ALADIN SWING PLAIN MONO /
ALADIN SWING PLAIN MONO KNOBS**

Pomolo senza blocco /
Knob without block

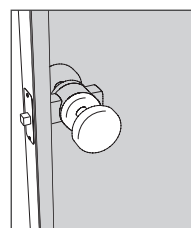

codice
code
PSB

Pomolo con chiusura privacy /
Knob with privacy lock

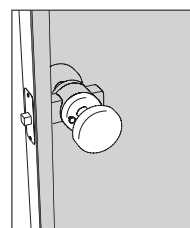

codice
code
PCP

Pomolo con chiave /
Knob with key lock

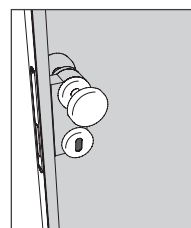

codice
code
PCC

Pomolo con cilindro /
Knob with cylinder lock

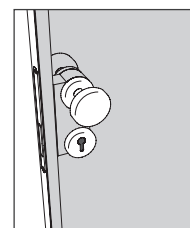

codice
code
PCY

**ALADIN SWING
FRAME MONO**

Aladin Swing Frame Mono è una porta a battente prodotta su misura, con stipite telescopico e cerniere a perno regolabili. Un vetro è applicato su un lato di un telaio, in modo da avere una faccia con superficie planare e l'altra con superficie arretrata rispetto alla cornice perimetrale d'alluminio. Il vetro può essere monolitico temperato 6 mm oppure stratificato 3 + 3 mm temperato, disponibile in una vastissima gamma di finiture. Tutti i vetri sono certificati secondo le normative di sicurezza ANSI Z97.1 e UNI EN 12150. Sono disponibili anche pannelli in gres con diverse finiture. È possibile montare diversi tipi di serratura e scegliere tra maniglia o pomolo che, come lo stipite, sono forniti nella stessa finitura del telaio. Disponibile anche nella versione filo soffitto.

Aladin Swing Frame Mono is a custom-made swing door with telescopic jamb and adjustable pivot hinges. A glass is applied on one side of the frame, so as to have a face with a flush surface, whilst the other surface is rebated from the perimeter aluminium frame. The glass can be monolithic tempered 6 mm in a single piece or tempered laminated 3 + 3 mm, available in a wide range of finishes. The glass is certified according to the safety regulation ANSI Z97.1 and UNI EN 12150. Panels in stoneware with different finishes are available, too. It is possible to assemble different kind of locks and choose between handle and knob which are provided, like the jamb, in the same finishes as the frame. Available also in the version with frame flush with the ceiling.

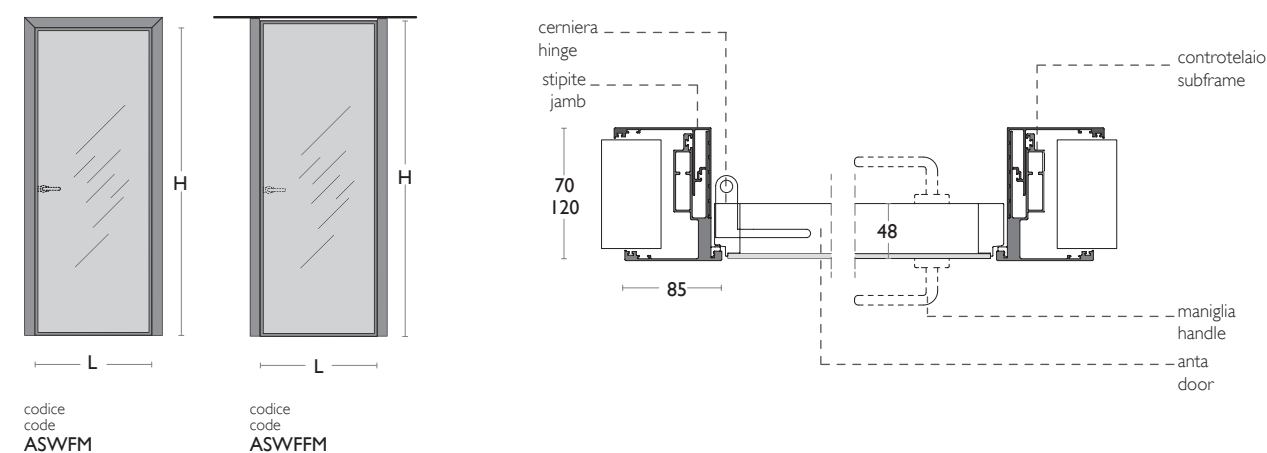

**IPOTESI PROGETTUALI /
PROJECT CONFIGURATIONS**

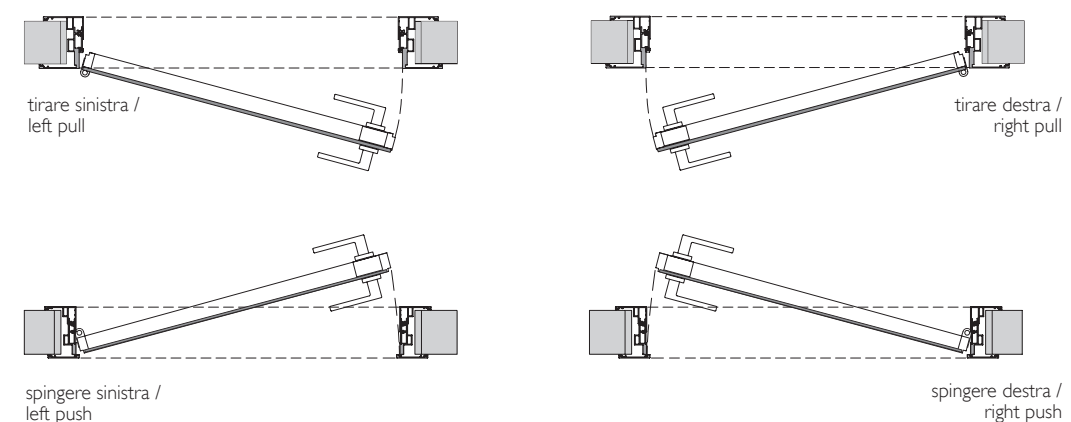

ALADIN SWING FRAME DUO

Aladin Swing Frame Duo è una porta a battente prodotta su misura, con stipite telescopico e cerniere a perno regolabili. Dei vetri temperati spessore 4 mm sono applicati su entrambe le facce di un telaio in alluminio, disponibile in quattro finiture, in modo da formare un volume con una camera d'aria interna. I vetri, disponibili in un'ampia gamma di finiture, sono certificati secondo le normative di sicurezza ANSI Z97.1 e UNI EN12150. Sono disponibili anche pannelli in gres o in legno, con diverse finiture ed essenze. È possibile montare diversi tipi di serratura e scegliere tra maniglia o pomolo che, come lo stipite, sono forniti nella stessa finitura del telaio. Disponibile anche nella versione filo soffitto.

Aladin Swing Frame Duo is a custom made swing door with telescopic jamb and adjustable pivot hinges. Tempered glass 4 mm thick is applied on both faces of an aluminium frame, available in four different finishes so as to form a volume with an internal air chamber. The glass is available in a wide range of finishes and it is certified according to the safety regulation ANSI Z97.1 and UNI EN12150. Panels in stoneware and in wood with different finishes and essences are available too. It is possible to assemble different kind of locks and choose between handle and knob which are provided, like the jamb, in the same finishes as the frame. Available also in the version with frame flush with the ceiling.

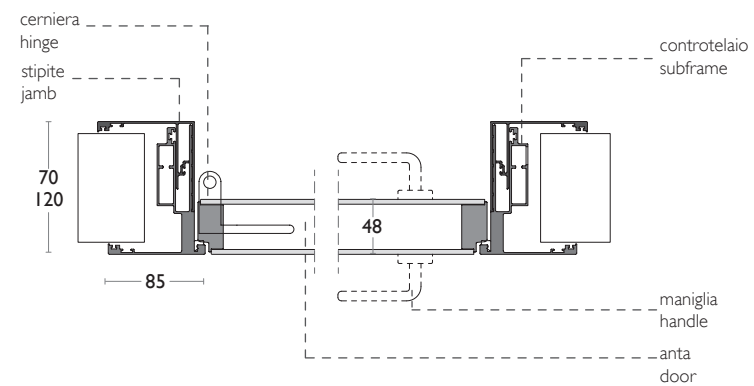
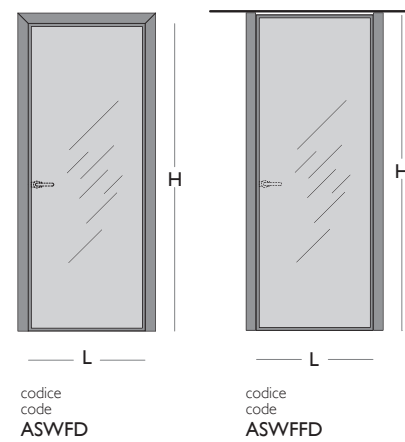

IPOTESI PROGETTUALI / PROJECT CONFIGURATIONS

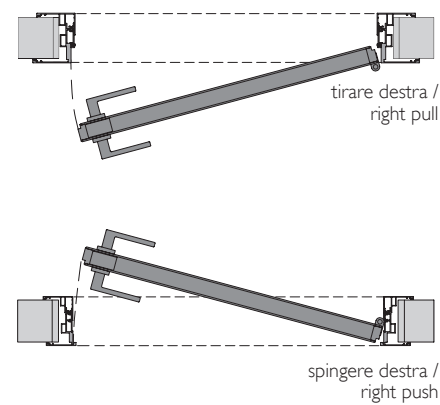
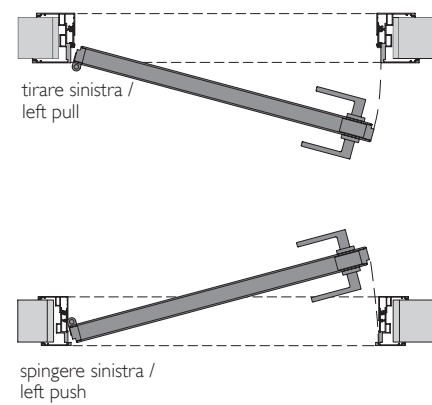

MANIGLIE ALADIN SWING FRAME DUO / ALADIN SWING FRAME DUO HANDLES

Maniglia senza blocco / Handle without block

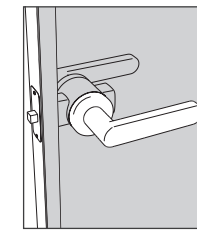

codice code
LSB

Maniglia con chiusura privacy / Handle with privacy lock

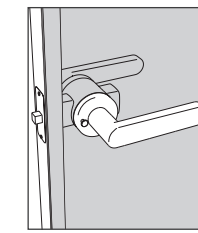

codice code
LCP

Maniglia con chiave / Handle with key lock

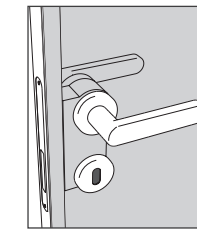

codice code
LCC

Maniglia con cilindro / Handle with cylinder lock

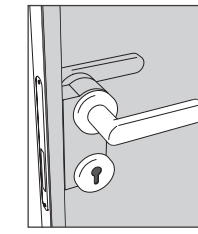

codice code
LCY

POMOLI ALADIN SWING FRAME DUO / ALADIN SWING FRAME DUO KNOBS

Pomolo senza blocco / Knob without block

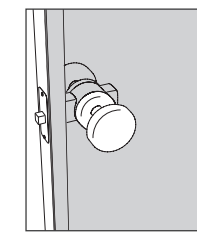

codice code
PSB

Pomolo con chiusura privacy / Knob with privacy lock

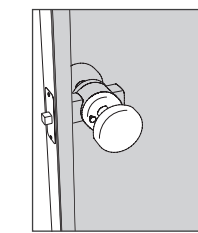

codice code
PCP

Pomolo con chiave / Knob with key lock

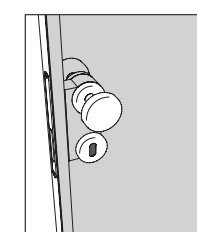

codice code
PCC

Pomolo con cilindro / Knob with cylinder lock

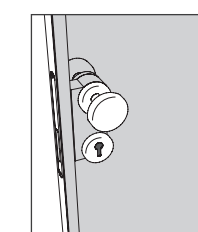

codice code
PCY

ALADIN PIVOT PLAIN MONO

Aladin Pivot Plain Mono è una porta a bilico raso muro prodotta su misura, con cerniere a perno regolabili. Un vetro è applicato su un lato di un telaio, in modo da avere una faccia con superficie planare e l'altra con superficie arretrata rispetto alla cornice perimetrale d'alluminio. Il vetro può essere monolitico temperato 6 mm oppure stratificato 3 + 3 mm, disponibile in una vastissima gamma di finiture. I vetri sono certificati secondo le normative di sicurezza ANSI Z97.1 e UNI EN12150. Sono disponibili anche pannelli in gres con diverse finiture. È possibile montare diversi tipi di serrature e scegliere tra maniglia o pomolo nella stessa finitura del telaio. Il controtelaio in alluminio decapato, invisibile quando la porta è chiusa, è disponibile sia per pareti cementizie sia in cartongesso e può essere verniciato direttamente con la pitturazione delle pareti.

Aladin Pivot Plain Mono is a custom-made pivot door with a concealed frame and with adjustable pivot hinges. A glass is applied on one side of the frame, so as to have a face with a flush surface, whilst the other surface is rebated from the perimeter aluminium frame. The glass can be monolithic tempered 6 mm in a single piece or laminated 3 + 3 mm, available in a wide range of finishes. The glass is certified according to the safety regulation ANSI Z97.1 and UNI EN12150. Panels in stoneware with different finishes are available, too. It is possible to assemble different locks and choose either between handle and knob in the finishes as the frame. The pickled aluminium subframe, invisible when the door is closed, is available for both cement walls and plasterboard and can be varnished during the painting of the walls.

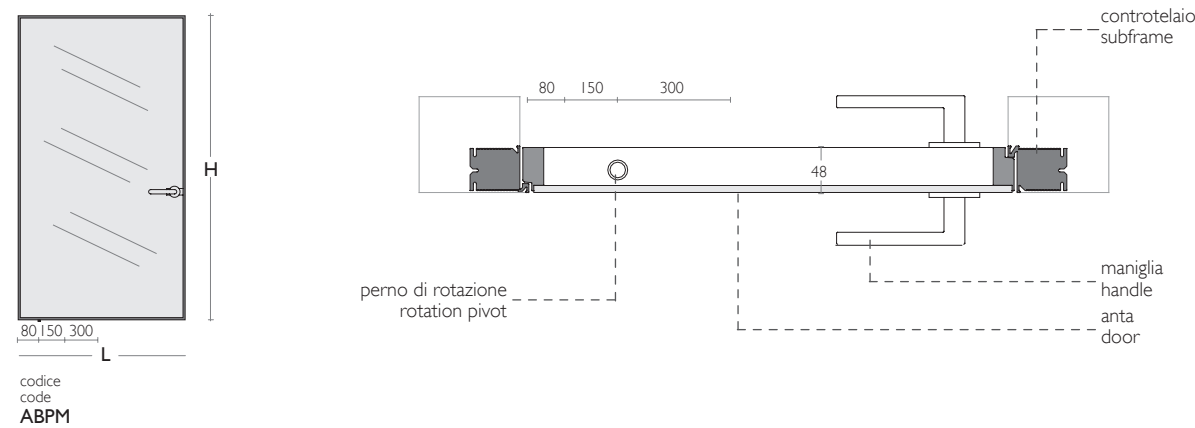

IPOTESI PROGETTUALI / PROJECT CONFIGURATIONS

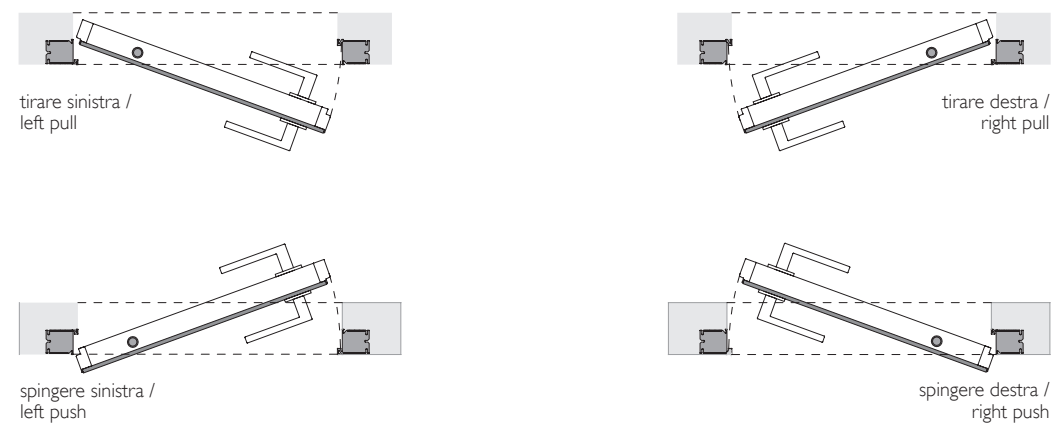

MANIGLIE ALADIN PIVOT PLAIN MONO / ALADIN PIVOT PLAIN MONO HANDLES

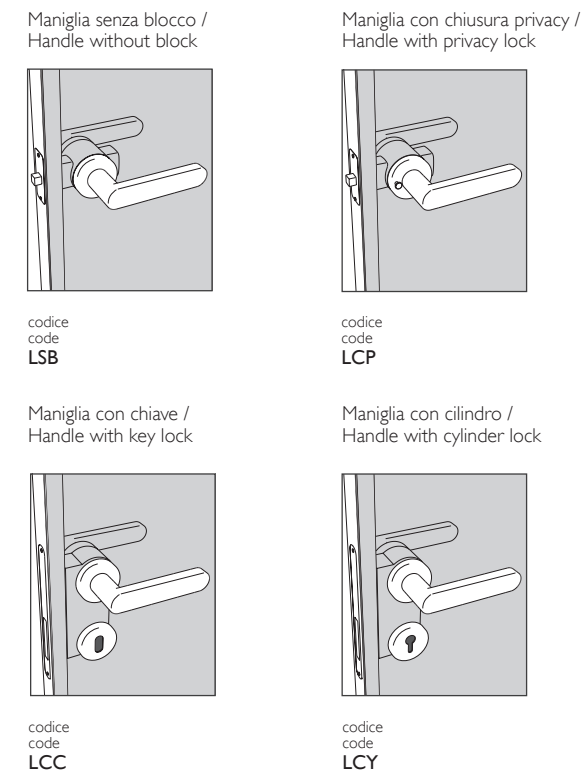

POMOLI ALADIN PIVOT PLAIN MONO / ALADIN PIVOT PLAIN MONO KNOBS

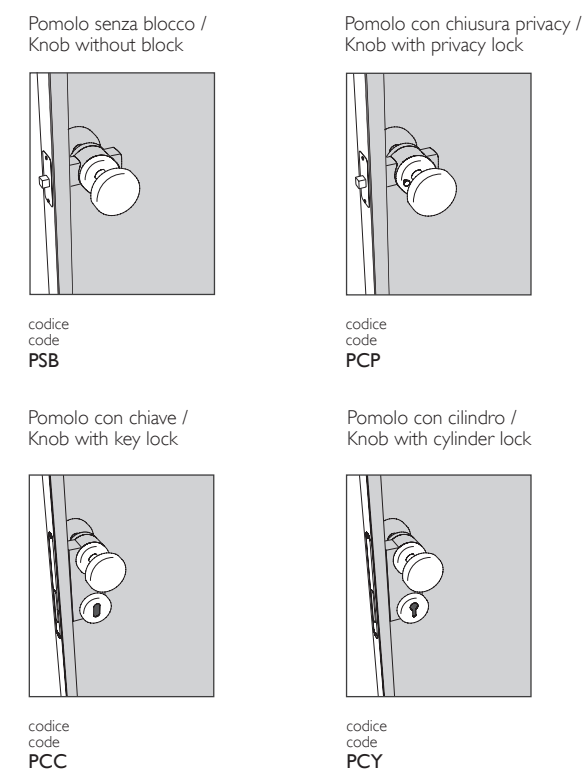

ALADIN PIVOT PLAIN DUO

Aladin Pivot Plain Duo è una porta a bilico raso muro prodotta su misura, con cerniere a perno regolabili. Dei vetri temperati spessore 4 mm sono applicati su entrambe le facce di untelaio in alluminio, disponibile in quattro finiture, in modo da formare un volume con una camera d'aria interna. I vetri, disponibili in un'ampia gamma di finiture, sono certificati secondo le normative di sicurezza ANSI Z97.1 e UNI EN12150. Sono disponibili anche pannelli in gres o in legno, con diverse finiture ed essenze. È possibile montare diversi tipi di serrature e scegliere tra maniglia o pomolo nella stessa finitura del telaio. Il controtelaio in alluminio decapato, invisibile quando la porta è chiusa, è disponibile sia per pareti cementizie sia in cartongesso e può essere verniciato direttamente con la pitturazione delle pareti.

Aladin Pivot Plain Duo is a custom-made pivot door with a concealed frame and with adjustable pivot hinges. Tempered glass 4 mm thick is applied on both faces of an aluminium frame, available in four different finishes, so as to form a volume with an internal air chamber. The glass is available in a wide range of finishes and it is certified according to the safety regulation ANSI Z97.1 and UNI EN12150. Panels in stoneware and in wood with different finishes and essences are available too. It is possible to assemble different locks and choose either between handle and knob in the same finish as the frame. The pickled aluminium subframe, invisible when the door is closed, is available for both cement walls and plasterboard and can be varnished during the painting of the walls.

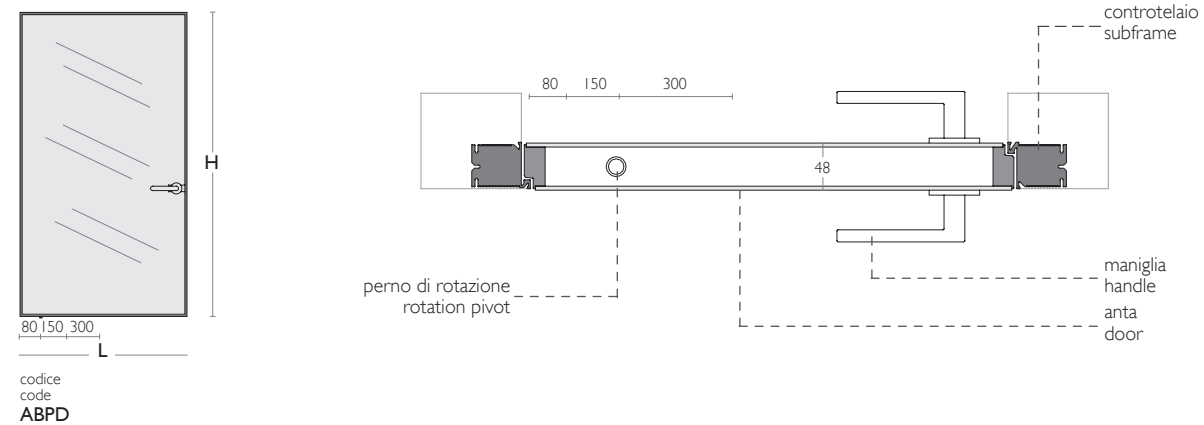

IPOTESI PROGETTUALI / PROJECT CONFIGURATIONS

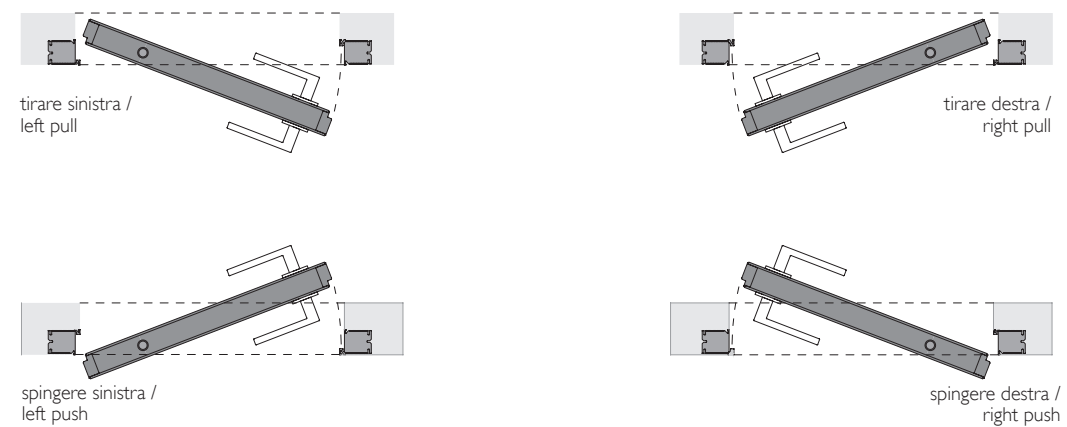

MANIGLIE ALADIN PIVOT PLAIN DUO / ALADIN PIVOT PLAIN DUO HANDLES

Maniglia senza blocco / Handle without block

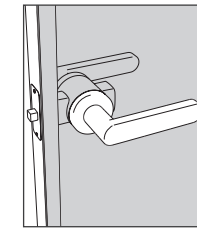

codice code
LSB

Maniglia con chiusura privacy / Handle with privacy lock

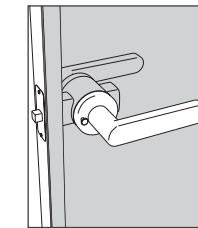

codice code
LCP

Maniglia con chiave / Handle with key lock

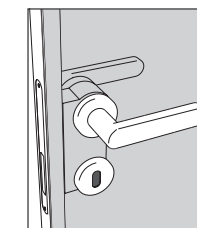

codice code
LCC

Maniglia con cilindro / Handle with cylinder lock

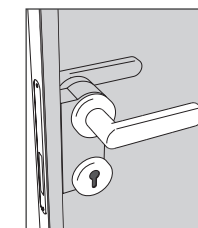

codice code
LCY

POMOLI ALADIN PIVOT PLAIN DUO / ALADIN PIVOT PLAIN DUO KNOBS

Pomolo senza blocco / Knob without block

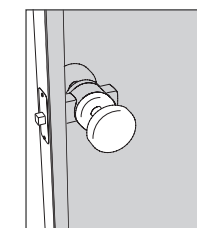

codice code
PSB

Pomolo con chiusura privacy / Knob with privacy lock



codice code
PCP

Pomolo con chiave / Knob with key lock

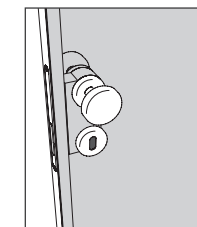

codice code
PCC

Pomolo con cilindro / Knob with cylinder lock

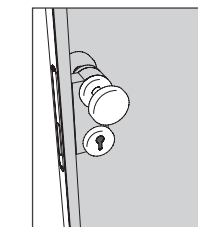

codice code
PCY

SHERAZADE SWING PLAIN

Sherazade Swing Plain è una porta a battente prodotta su misura, che si distingue per la grande pulizia formale e la cura dei dettagli, in cui il telaio dell'anta è a raso muro. Un vetro temperato monolitico da 6 mm, o stratificato da 3+3 mm, è inserito tramite una guarnizione nel telaio d'alluminio, fornito in quattro diverse finiture.

I vetri, disponibili in una vastissima gamma di finiture, sono certificati secondo le normative di sicurezza ANSI Z97.1 e UNI ENI 2150.

Sono disponibili anche pannelli in gres o in legno, con diverse finiture ed essenze. È possibile montare tre tipi di serratura (senza blocco, con cilindro, con nottolino) e scegliere tra maniglia o pomolo, che sono forniti nella stessa finitura del telaio. Le cerniere sono a perno regolabili.

Il controtelaio in alluminio decapeato, invisibile quando la porta è chiusa, è disponibile sia per pareti cementizie sia in cartongesso e può essere verniciato direttamente con la pitturazione delle pareti.

Sherazade Swing Plain is a custom made swing door with a concealed frame, which stands out for its clean lines and attention to detail, whose door panel fits flush to the wall.

The monolithic 6 mm, or laminated 3+3 mm, thick tempered glass is inserted by means of a seal in the aluminium frame, which is supplied in four different finishes.

The glass is available in a wide range of finishes and it is certified according to the safety regulations ANSI Z97.1 and UNI ENI 2150.

Panels in stoneware and in wood with different finishes and essences are available too.

It is possible to assemble three kinds of lock (without block, with cylinder, with revolving plug) and choose between handle or knob and they are supplied in the same finish of the frame.

The hinges are with adjustable pivot. The pickled aluminium subframe, invisible when the door is closed, is available for both cement and plasterboard walls and it can be varnished during the painting of the walls.

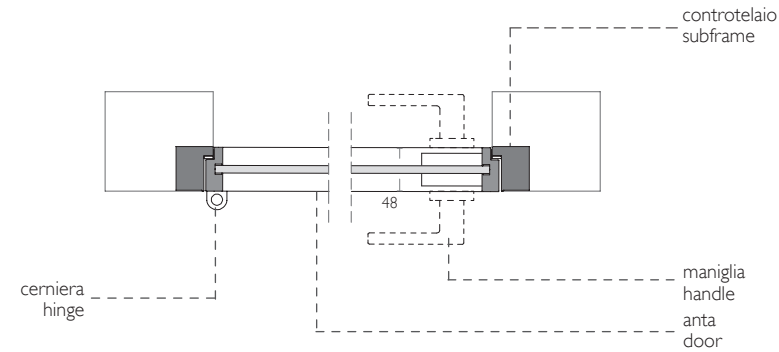
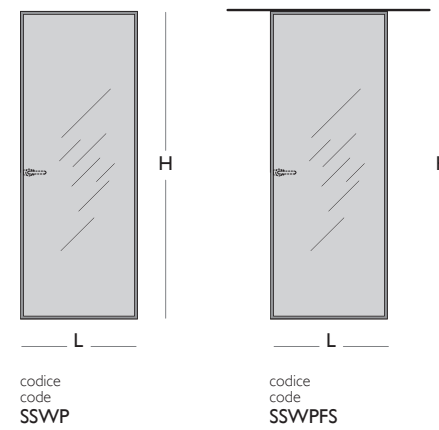

IPOTESI PROGETTUALI / PROJECT CONFIGURATIONS

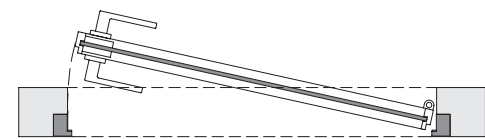
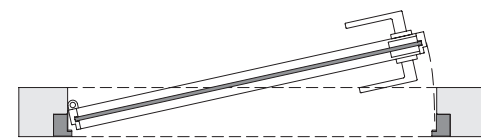
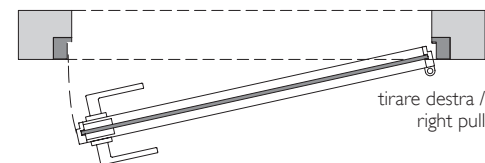
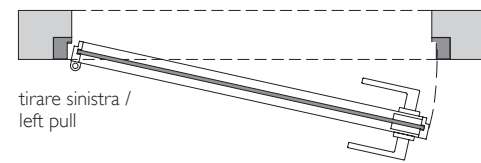

MANIGLIE SHERAZADE SWING PLAIN / SHERAZADE SWING PLAIN HANDLES

Maniglia senza blocco / Handle without block

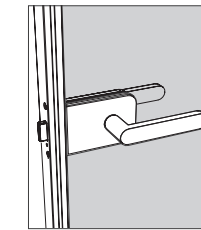

codice code **LSSB**

Maniglia con cilindro / Handle with cylinder lock

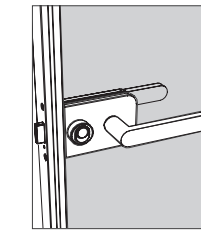

codice code **LSCY**

Maniglia con nottolino / Handle with revolving plug

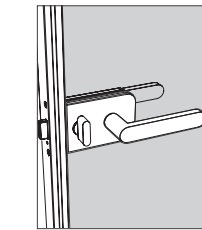

codice code **LSCN**

POMOLI SHERAZADE SWING PLAIN / SHERAZADE SWING PLAIN KNOBS

Pomolo senza blocco / Knob without block

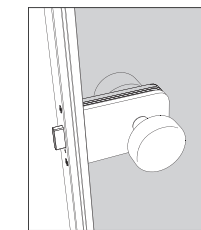

codice code **PSSB**

Pomolo con cilindro / Knob with cylinder lock

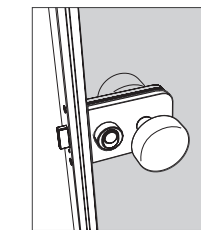

codice code **PSCY**

Pomolo con nottolino / Knob with revolving plug

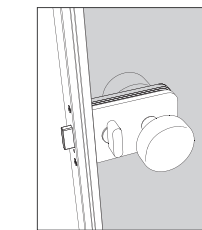

codice code **PSCN**

SHERAZADE SWING FRAME

Sherazade Swing Frame è una porta a battente prodotta su misura, che si distingue per la grande pulizia formale e la cura dei dettagli, con stipite telescopico e cerniere a perno regolabili.

Un vetro temperato monolitico da 6 mm o stratificato da 3+3 mm è inserito tramite guarnizione in un telaio d'alluminio, fornito in quattro diverse finiture.

I vetri, disponibili in una vastissima gamma di finiture, sono certificati secondo le normative di sicurezza ANSI Z97.1 e UNI ENI 2150.

Sono disponibili anche pannelli in gres o in legno, con diverse finiture ed essenze. È possibile montare tre tipi di serratura (senza blocco, con cilindro, con nottolino) e scegliere tra maniglia o pomolo che, come lo stipite, sono forniti nella stessa finitura del telaio.

Sherazade Swing Frame is a custom made swing door with a telescopic jamb and adjustable pivot hinges, which stands out for its clean lines and attention to detail. The monolithic 6 mm, or laminated 3+3 mm, thick tempered glass is inserted by means of a seal in the aluminum frame, which is supplied in four different finishes.

The glass is available in a wide range of finishes and it is certified according to the safety regulations ANSI Z97.1 and UNI ENI 2150.

Panels in stoneware and in wood with different finishes and essences are available too.

It is possible to assemble three kinds of lock (without block, with cylinder, with revolving plug) and choose between handle or knob and, like the jamb, they are supplied in the same finish of the frame.

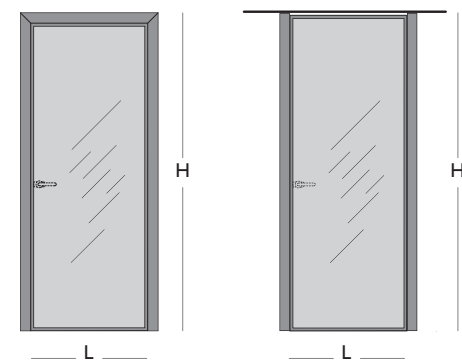

codice
code
SSWF

codice
code
SSWFFS

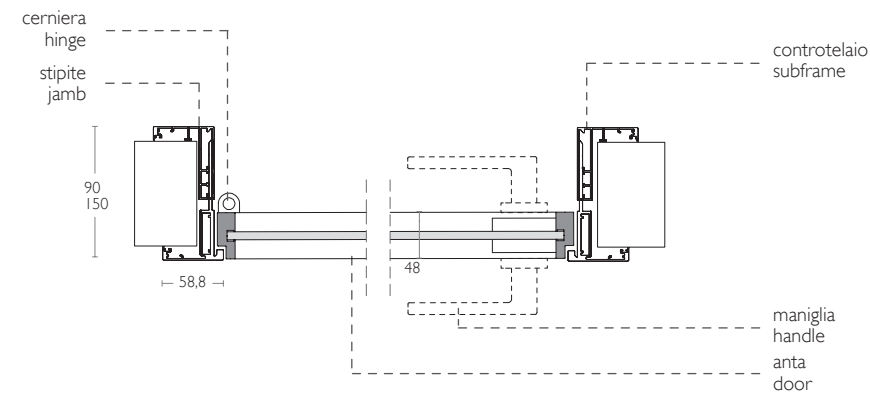

IPOTESI PROGETTUALI / PROJECT CONFIGURATIONS

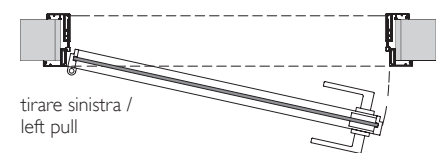

tirare sinistra /
left pull

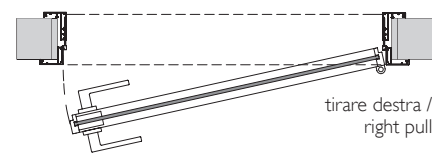

tirare destra /
right pull

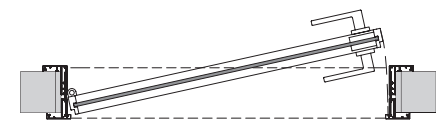

spingere sinistra /
left push

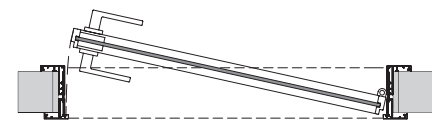

spingere destra /
right push

MANIGLIE SHERAZADE SWING FRAME / HANDLES SHERAZADE SWING FRAME

Maniglia senza blocco /
Handle without block

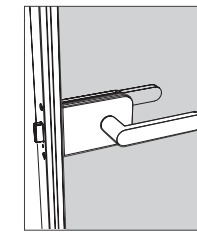

codice
code
LSSB

Maniglia con cilindro /
Handle with cylinder lock

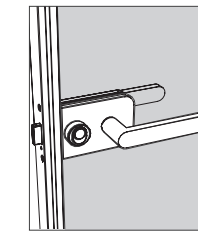

codice
code
LSCY

Maniglia con nottolino /
Handle with revolving plug

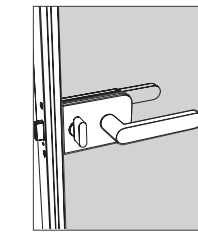

codice
code
LSCN

POMOLI SHERAZADE SWING FRAME / KNOBS SHERAZADE SWING FRAME

Pomolo senza blocco /
Knob without block

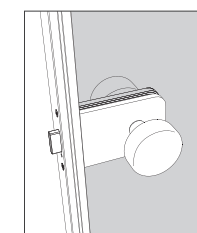

codice
code
PSSB

Pomolo con cilindro /
Knob with cylinder lock

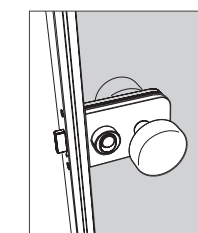

codice
code
PSCY

Pomolo con nottolino /
Knob with revolving plug

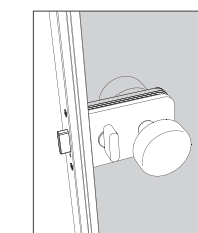

codice
code
PSCN

SHERAZADE SLIDE

Sherazade Slide è un'anta caratterizzata da grande eleganza e cura dei dettagli, con vetro temperato monolitico da 6 mm o stratificato 3+3 mm inserito tramite una guarnizione al centro di un telaio d'alluminio, fornito in quattro diverse finiture.

I vetri, disponibili in una vastissima gamma di finiture, sono certificati secondo le normative di sicurezza ANSI Z97.1 e UNI ENI 2150.

Sono disponibili anche pannelli in gres o in legno, con diverse finiture ed essenze.

Sherazade Slide is a door characterized by great elegance and attention to details. The monolithic 6 mm, or laminated 3+3 mm thick tempered glass is inserted by means of a seal in the center of the aluminium frame, which is supplied in four different finishes.

The glass is available in a wide range of finishes and it is certified according to the safety regulations ANSI Z97.1 and UNI ENI 2150.

Panels in stoneware and in wood with different finishes and essences are available too.

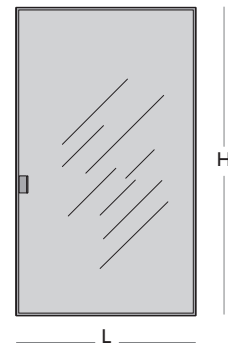

codice
code
SSL

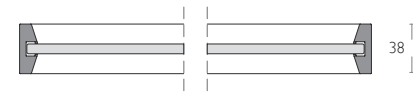

MANIGLIE SHERAZADE SLIDE / SHERAZADE SLIDE HANDLES

Maniglia senza supporto / Handle without support

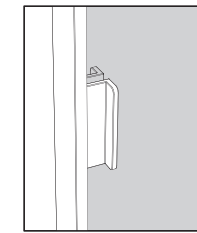

codice
code
MSSS

Maniglia con supporto / Handle with support

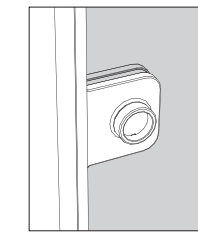

codice
code
MCSS

Maniglia con nottolino / Handle with revolving plug

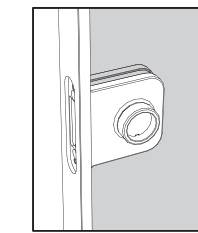

codice
code
MCNS

SHERAZADE POCKET

Le ante **Sherazade Pocket**, prodotte su misura e perfettamente integrabili nei più diffusi sistemi di porte scorrevoli a scomparsa senza stipite, quali Scigno Essential® Scorrevole ed Eclisse® SyntesisLine, hanno un vetro temperato monolitico da 6 mm o stratificato 3+3 mm inserito tramite una guarnizione al centro di un telaio d'alluminio, fornito in quattro diverse finiture. I vetri, disponibili in una vastissima gamma di finiture, sono certificati secondo le normative di sicurezza ANSI Z97.1 e UNI ENI 2150. Sono disponibili anche pannelli in gres o in legno, con diverse finiture ed essenze. Le due versioni ad anta singola e ad anta doppia possono essere fornite con o senza serratura. A richiesta vengono forniti anche i controtelai per cartongesso e intonaco.

The Sherazade Pocket doors are custom-made, can be integrated into the most common systems of frameless sliding pocket doors such as Scigno Essential® sliding and Eclisse® Syntesis Line. The monolithic 6 mm. or laminated glass 3+3 mm thick tempered glass is inserted by means of a seal in the center of the aluminum frame, which is supplied in four different finishes. The glass, available in a wide range of finishes is certified according to the safety regulation ANSI Z97.1 and UNI ENI 2150. Panels in stoneware and in wood with different finishes and essences are available too. The two versions, with single or double door, can be supplied with or without the lock. Subframes for plasterboard or brick walls can be provided on demand.

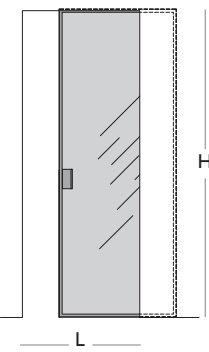

codice SPO1

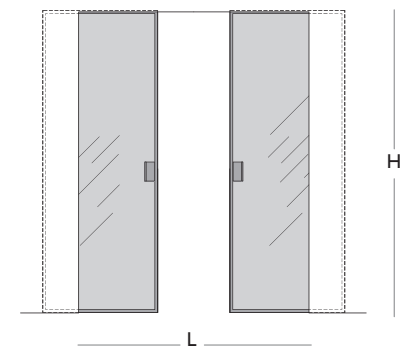
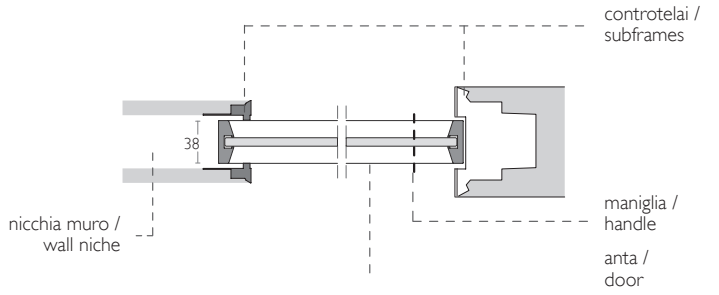

codice SPO2

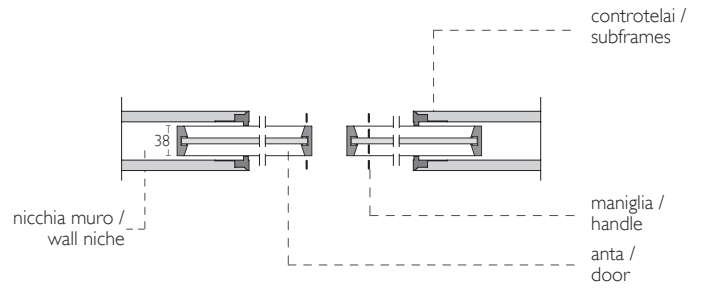

MANIGLIE SHERAZADE POCKET ANTA SINGOLA / SHERAZADE POCKET SINGLE DOOR HANDLES

Maniglia senza supporto / Handle without support

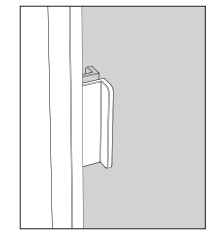

codice code M2SSS

Maniglia con supporto / Handle with support

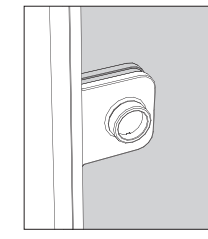

codice code M2CSS

Maniglia con nottolino / Handle with revolving plug

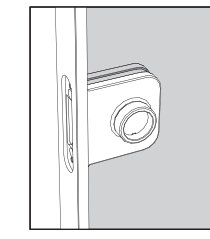

codice code M2CNS

MANIGLIE SHERAZADE POCKET ANTA DOPPIA / SHERAZADE POCKET DOUBLE DOOR HANDLES

Maniglia senza supporto / Handle without support

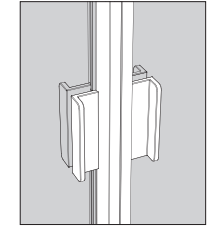

codice code M2SSS

Maniglia con supporto / Handle with support

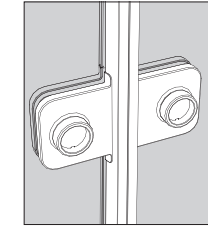

codice code M2CSS

Maniglia con nottolino / Handle with revolving plug

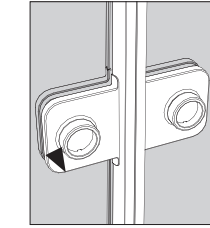

codice code M2CNS

SHERAZADE POCKET FRAME

Le ante Sherazade Pocket Frame, prodotte su misura e perfettamente integrabili nei più diffusi sistemi di porte scorrevoli a scomparsa senza stipite, quali Scigno Essential® Scorrevole ed Eclisse® SyntesisLine, hanno un vetro temperato monolitico da 6 mm o stratificato 3+3 mm inserito tramite una guarnizione al centro di un telaio d'alluminio, fornito in quattro diverse finiture.

I vetri, disponibili in una vastissima gamma di finiture, sono certificati secondo le normative di sicurezza ANSI Z97.1 e UNI EN 12150.

Sono disponibili anche pannelli in gres o in legno, con diverse finiture ed essenze. Le due versioni ad anta singola e ad anta doppia possono essere fornite con o senza serratura.

A richiesta vengono forniti anche i controtelai per cartongesso e intonaco.

The Sherazade Pocket Frame doors are custom-made, can be integrated into the most common systems of frameless sliding pocket doors such as Scigno Essential® sliding and Eclisse® Syntesis Line.

The monolithic 6 mm. or laminated glass 3+3 mm thick tempered glass is inserted by means of a seal in the center of the aluminum frame, which is supplied in four different finishes.

The glass, available in a wide range of finishes is certified according to the safety regulation ANSI Z97.1 and UNI EN 12150.

Panels in stoneware and in wood with different finishes and essences are available too.

The two versions, with single or double door, can be supplied with or without the lock.

Subframes for plasterboard or brick walls can be provided on demand.

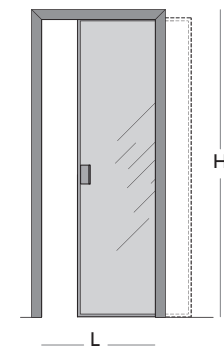

codice
SPOFI

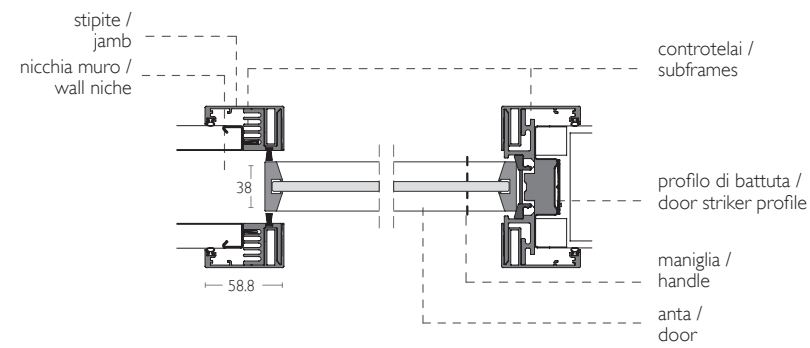

IPOTESI PROGETTUALI / PROJECT CONFIGURATIONS

apertura destra /
right opening



apertura sinistra /
left opening

MANIGLIE SHERAZADE POCKET FRAME ANTA SINGOLA / SHERAZADE POCKET FRAME SINGLE DOOR HANDLES

Maniglia senza supporto /
Handle without support

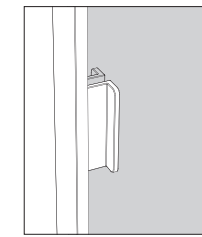

codice
code
MSSS

Maniglia con supporto /
Handle with support

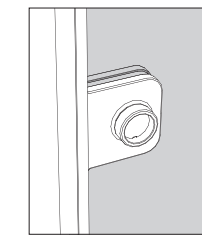

codice
code
MCSS

Maniglia con nottolino /
Handle with revolving plug

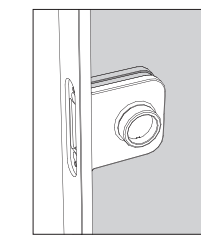

codice
code
MCNS

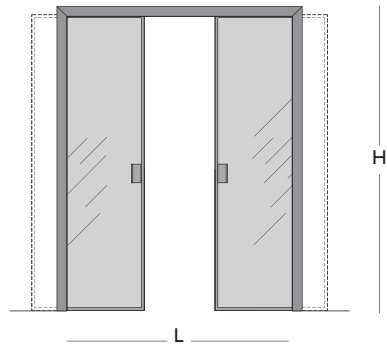

codice
SPOF2M

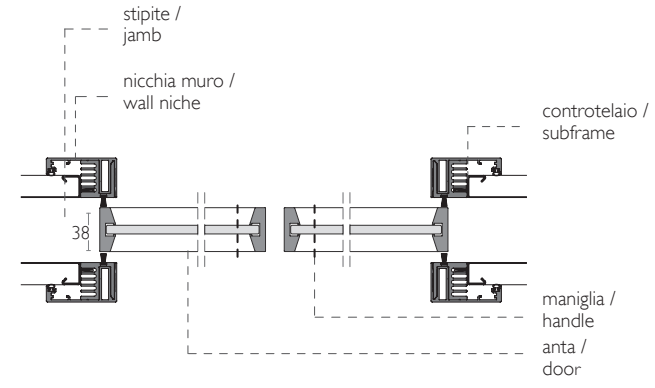

**IPOTESI PROGETTUALI /
PROJECT CONFIGURATIONS**

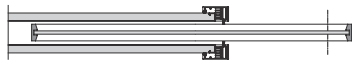

doppia apertura /
double opening

**MANIGLIE SHERAZADE POCKET FRAME ANTA DOPPIA /
SHERAZADE POCKET FRAME DOUBLE DOOR HANDLES**

Maniglia doppia senza supporto /
Double handle without support

Maniglia doppia con supporto /
Double handle with support

Maniglia doppia con nottolino /
Double handle with revolving plug

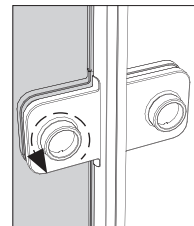
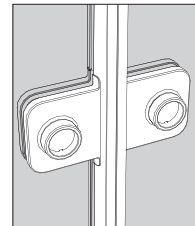
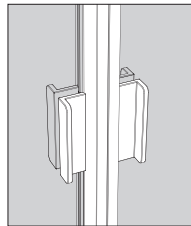

codice
code
M2SSS

codice
code
M2CSS

codice
code
M2CNS

FINITURE ALLUMINIO / ALUMINIUM FINISHES

LACCATO OPACO /
MATT LACQUERED



300. verniciato bianco RAL9016

ANODIZZATO /
ANODIZED

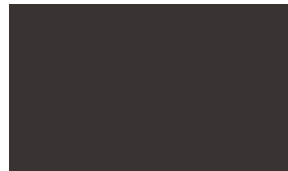

313. anodizzato bronzo S



314. anodizzato dark brown S

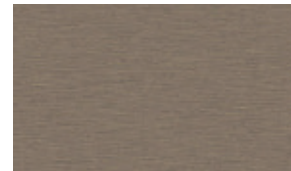

315. anodizzato inox S

FINITURE CRISTALLI / GLASS FINISHES

CRISTALLI TRASPARENTI /
TRANSPARENT GLASS

CRISTALLI TRASPARENTI NEUTRI /
NEUTRAL TRANSPARENT GLASS



500. extralight



501. fumé



502. bronzo

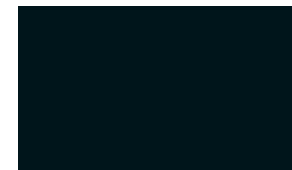

503. dark grey

CRISTALLI TRASPARENTI COLORATI /
TRANSPARENT COLOURED GLASS



95. blu chiaro



97. blu profondo



98. viola



99. rosa



100. rosso



101. arancio



102. ambra



103. verde



115. giallo sole

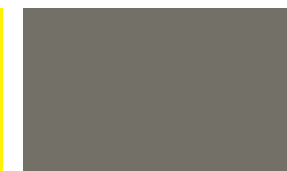

116. grigio caldo



117. arancio rosato



118. cedro

CRISTALLI RIFLETTENTI /
REFLECTING GLASS

CRISTALLI RIFLETTENTI TRASPARENTI /
REFLECTING TRANSPARENT GLASS



504. riflettente chiaro

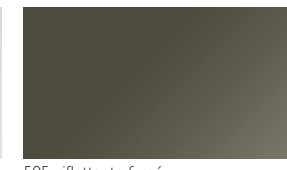

505. riflettente fumé

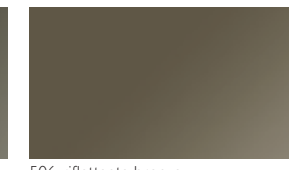

506. riflettente bronzo

CRISTALLI RIFLETTENTI ACIDATI /
REFLECTING ACID-ETCHED GLASS



508. acidato riflettente chiaro

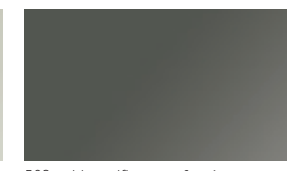

509. acidato riflettente fumé

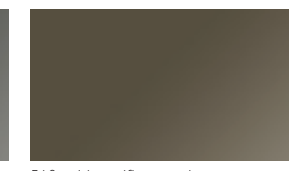

510. acidato riflettente bronzo

SPECCHIO /
MIRROR

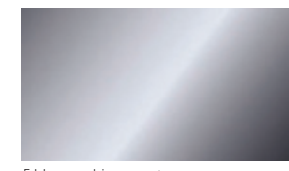

511. specchio argento

**CRISTALLI LACCATI /
LACQUERED GLASS**

CRISTALLI LACCATI LUCIDI (CRISTALLI LACCATI) /
GLOSSY LACQUERED GLASS (LACQUERED GLASS)



CRISTALLI LACCATI RIFLETTENTI /
REFLECTING LACQUERED GLASS



CRISTALLI LACCATI OPACHI (CRISTALLI SATINATI OPACHI) /
MATT LACQUERED GLASS (OPAQUE SATIN GLASS)



**CRISTALLI DIFFUSORI /
DIFFUSER GLASS**

CRISTALLI DIFFUSORI COLORATI OPACHI /
OPAQUE COLOURED DIFFUSER GLASS

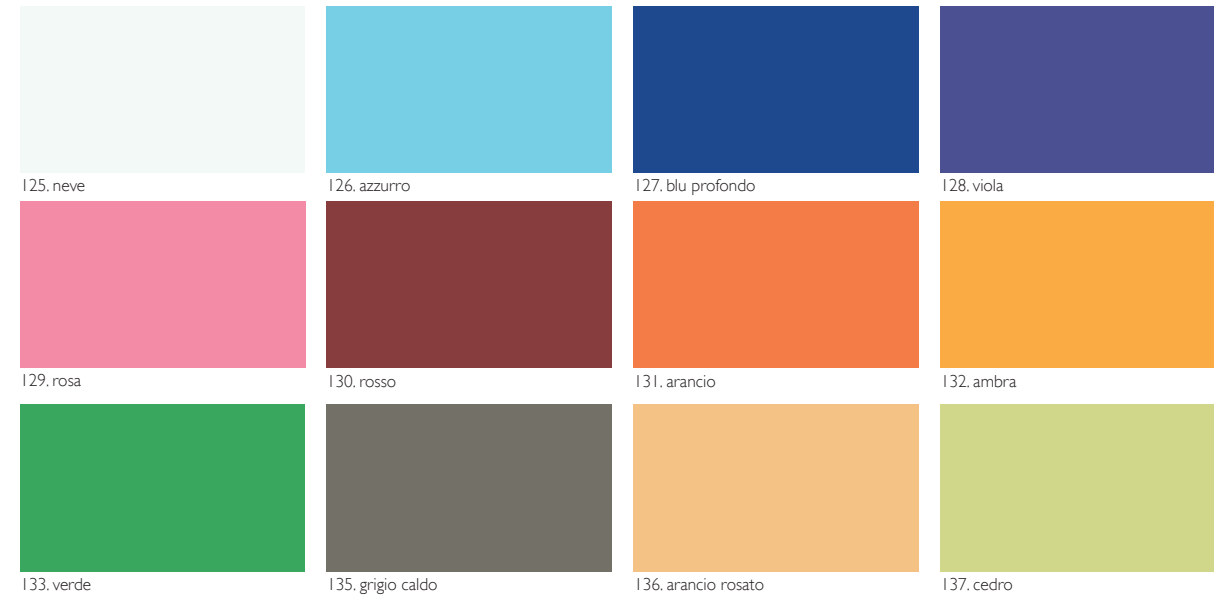

CRISTALLI DIFFUSORI COLORATI LUCIDI /
GLOSSY COLOURED DIFFUSER GLASS

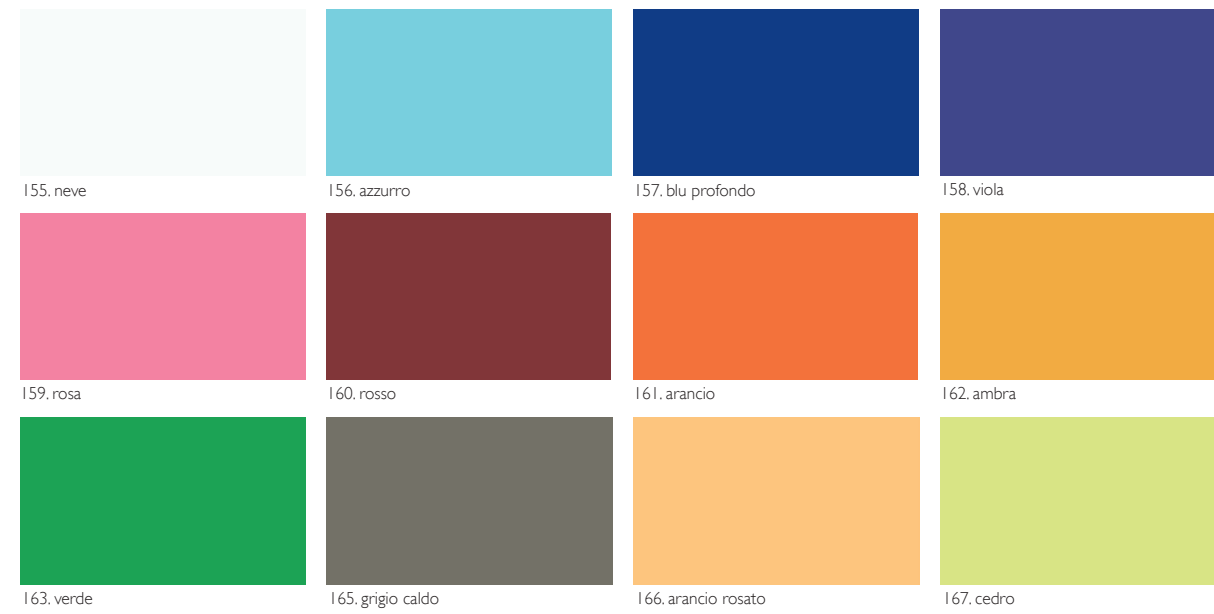

CRISTALLI ACIDATI MONOFACCIALI /
SINGLE FACED ACID-ETCHED GLASS



CRISTALLI ACIDATI BIFACCIALI /
DOUBLE FACED ACID-ETCHED GLASS

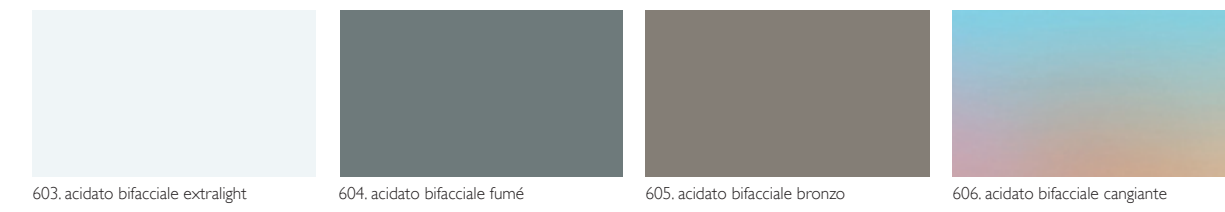

**CRISTALLI STAMPATI /
PATTERNED GLASS**

CRISTALLI STAMPATI TRASPARENTI /
TRANSPARENT PATTERNED GLASS



CRISTALLI STAMPATI ACIDATI /
ACID-ETCHED PATTERNED GLASS



**CRISTALLI CON RETE /
GLASS WITH MESH**

CRISTALLI EXTRALIGHT CON RETE /
EXTRALIGHT GLASS WITH MESH



530. light

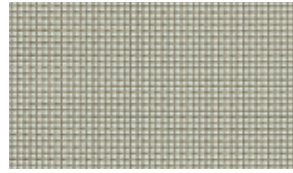

531. wide bronze

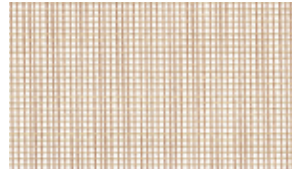

532. wide gold

**CRISTALLI CON TESSUTI /
GLASS WITH FABRICS**

CRISTALLI EXTRALIGHT CON TESSUTI /
EXTRALIGHT GLASS WITH FABRICS

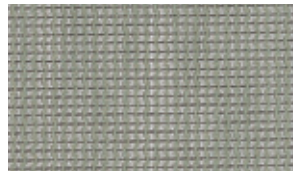

550. giotto

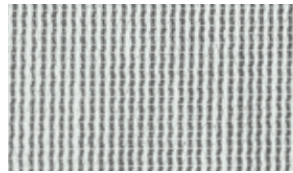

551. raffaello



552. masaccio

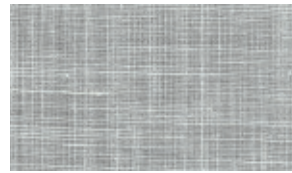

553. botticelli



554. carta di riso lucida



555. carta di riso opaca



556. pura seta crema



557. pura seta grigio

**CRISTALLI DECORATI "PATTERN" /
"PATTERN" DECORATED GLASS**

CRISTALLO EXTRALIGHT SFUMATO /
SHADED EXTRALIGHT GLASS



620. bianco



621. dark brown

CRISTALLO RIFLETTENTE SFUMATO /
SHADED REFLECTING GLASS



622. bianco



623. dark brown

**CRISTALLI DECORATI "LIFE" /
"LIFE" DECORATED GLASS**

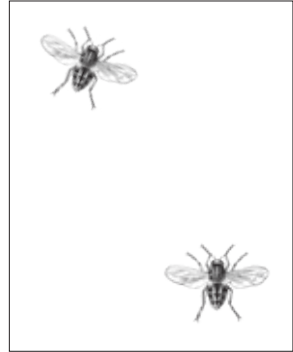

630. mosche

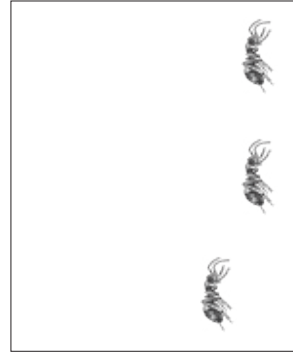

631. formiche



632. farfalle



633. pesci



634. rana



635. fiore A



637. fiore B

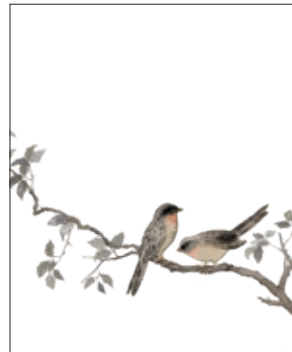

636. ramo

**FINITURE PANNELLI
PANELS FINISHES**

LEGNI
WOODS



700. Rovere
fiammato bianco

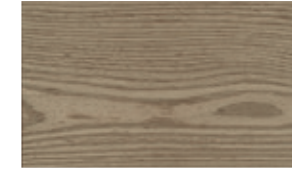

701. Rovere
fiammato sabbia



702. Rovere
fiammato tabacco



703. Rovere
fiammato nero



704. Ebano rigato

GRES
STONEWARE



800. Pietra grigio chiaro

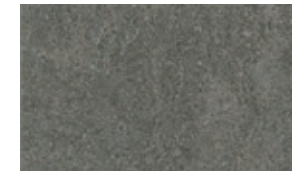

801. Pietra grigio medio



802. Pietra antracite

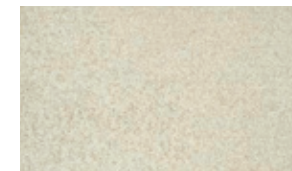

803. Cemento perla

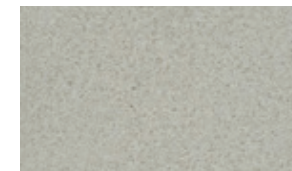

804. Cemento grigio chiaro

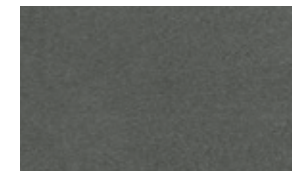

805. Cemento grigio medio

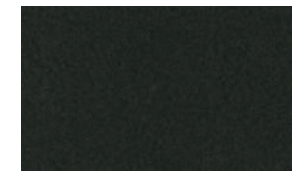

806. Cemento antracite

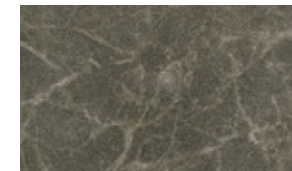

807. Marmo Atlas marrone

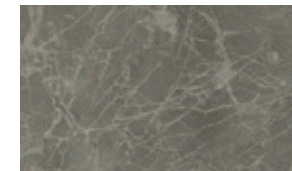

808. Marmo Atlas grigio

progetto grafico:
Graph.x

foto:
Tommaso Sartori
Mimo Visconti

pag. 13, 20, 21, 28, 29, 36, 37, 99>101,104>107,110>113

styling:
Elisa Ossino

thanks to:
Fontana Arte
Golran
Living Divani
Stefano Pugliese

fotolito:
Repro S

stampa:
Alecom srl, 2018

