

**DIVANI
SOFAS**

PIANCA

DIVANI SOFAS

PIANCA

Ricerca estetica e formale al servizio del comfort e della praticità. I divani e le poltrone PIANCA offrono una scelta vasta e completa di modelli interamente sfoderabili, arricchita da ulteriori varianti e molteplici possibilità di personalizzazione.

Essenziali, eleganti, informali, versatili, componibili: a ciascun modello la sua personalità, il suo design ricercato e riconoscibile, le sue proporzioni, il suo caratteristico basamento.

Comune a tutti è la grande cura ai dettagli, dalla fase progettuale alla realizzazione, espressione dello stile e della qualità Made in Italy, di cui PIANCA è portabandiera.

Pursuing the ultimate in aesthetic quality and form in the name of comfort and practicality. PIANCA sofas and armchairs offer a vast and comprehensive selection of models with fully removable covers, supplemented further with an array of different options and plenty of scope for customization.

Pared back, elegant, casual, versatile, modular: each model has its own personality, its own stylish design setting it apart, its own proportions and its own distinctive base. All share a common denominator: painstaking attention to detail - from the drawing board to the production line - epitomizing the style and quality of the Made in Italy brand championed by PIANCA.

INDICE/INDEX

DIVANI / SOFAS

ASOLO **11**
BOSTON **27**
VOLO **45**
DELANO **61**
NEWPORT **79**
TIME **97**
EDEN **113**
PALIO **129**
MOOD **145**
DUO **159**
INCONTRO **175**
MERIDIANO **189**
OTTO **201**

POLTRONE / ARMCHAIRS

DORA **212**
DIALOGO **216**
OPLÀ **220**
PAESAGGIO **222**
ISOTTA **226**
DOLCEVITA **228**
POUF **230**

TESSUTI E PELLI / FABRICS AND LEATHER 235

DIVANI/SOFAS



ASOLO
PAGINA 11



PALIO
PAGINA 129



TIME
PAGINA 97



VOLO
PAGINA 45



BOSTON
PAGINA 27



DELANO
PAGINA 61



DUO
PAGINA 159



EDEN
PAGINA 113



INCONTRO
PAGINA 175



MERIDIANO
PAGINA 189



MOOD
PAGINA 145



NEWPORT
PAGINA 79



OTTO
PAGINA 201

POLTRONE/ARMCHAIRS



DIALOGO
PAGINA 216



DOLCEVITA
PAGINA 228



DORA
PAGINA 212



ISOTTA
PAGINA 226



OPLÀ
PAGINA 220



PAESAGGIO
PAGINA 222



POUF
PAGINA 230

ASOLO



ASOLO

Design by Emilio Nanni

La geometria danza in punta di piedi e con elegante pulizia disegna le forme asciutte e ricercate di Asolo. I volumi sono ridotti, la struttura dello schienale è monoscocca, a favore di un comfort che cerca l'essenzialità formale. Un meccanismo di movimento scorrevole permette di avere sedute da conversazione trasformabili, in un semplice gesto, in comode sedute da relax. Sottolineati dalle cuciture a busta del rivestimento, i sottili e geometrici braccioli di Asolo ne rappresentano l'elemento più caratterizzante, in perfetta continuità con il basamento a slitta, disponibile in metallo laccato opaco nei colori della collezione, nelle finiture metallizzate e cromate.

Geometry trips the light fantastic and with a clean-lined elegance draws the lean, stylish shapes that give Asolo its character. Volumes have been slimmed down, the backrest cushions and carcass are one and the same, showing that comfort can successfully embrace a pared-back aesthetic. A sliding mechanism effortlessly transforms conversational seating into a comfy spot for relaxing. Stitching on the covers in an envelope flap design underlines the slim, geometric armrests that are Asolo's greatest distinguishing trait, a seamless continuation of the matt lacquered metal skid base, which can be ordered in any of the collection's colours as well as a range of metallic or chrome finishes.



ASOLO L 180 H 75 P 95
IN PELLE SOFTY 61 CON BASAMENTO
TITANIO, TAVOLINO **ICARO** CON
PIANO MARMO EMPERADOR LUCIDO
E STRUTTURA CROMO, TAVOLINO
SERVOQUADRO CON PIANO
LACCATO OPACO LAVAGNA
E STRUTTURA CROMO

ASOLO W 180 H 75 D 95
IN SOFTY 61 LEATHER AND TITANIUM
BASE, **ICARO** COFFEE TABLE WITH
GLOSSY EMPERADOR MARBLE
TOP AND CHROME STRUCTURE,
SERVOQUADRO COFFEE TABLE
WITH LAVAGNA MATT LACQUERED
TOP AND CHROME STRUCTURE



ASOLO L 377 H 75 P 345
E POLTRONA L 140 H 75 P 95
IN TESSUTO PASCA 02 CON
BASAMENTO BRONZO, TAVOLINO
ANTONIETTA BIANCO, TAVOLINI
ICARO CON PIANO MARMO LUCIDO
GIOIA CARRARA, EMPERADOR
E STRUTTURA BRONZO

ASOLO W 377 H 75 D 345
AND ARMCHAIR W 140 H 75 D 95
IN PASCA 02 FABRIC WITH BRONZE
BASE, BIANCO **ANTONIETTA** SIDE
TABLE, **ICARO** COFFEE TABLES
WITH GIOIA CARRARA, GLOSSY
EMPERADOR MARBLE TOP AND
BRONZE STRUCTURE

ASOLO L 355 H 75 P 160
IN TESSUTO THALIS UNITO 22 CON
BASAMENTO TITANIO, POLTRONE
OPLÀ IN TESSUTO VELVET 31,
TAVOLINI **MONO** LACCATO OPACO
CIELO E PIOMBO, COMPOSIZIONE
SPAZIOTECA

ASOLO W 355 H 75 D 160
IN THALIS UNITO 22 FABRIC AND
TITANIUM BASE, **OPLÀ** ARMCHAIRS
IN VELVET 31 FABRIC, CIELO AND
PIOMBO MATT LACQUERED **MONO**
COFFEE TABLES, **SPAZIOTECA**
COMPOSITION





ASOLO L 260 H 75 P 95
IN TESSUTO PASCA 52 CON
BASAMENTO TITANIO, TAVOLINI
1+1 CON PIANO E STRUTTURA
LACCATO OPACO PIOMBO

ASOLO W 260 H 75 D 95
IN PASCA 52 FABRIC AND TITANIUM
BASE, 1+1 COFFEE TABLES WITH
PIOMBO MATT LACQUERED TOP AND
STRUCTURE





SEDUTA CON MECCANISMO ESTRAIBILE
PULL-OUT SEAT

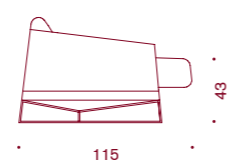
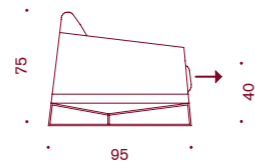
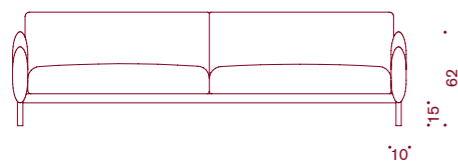
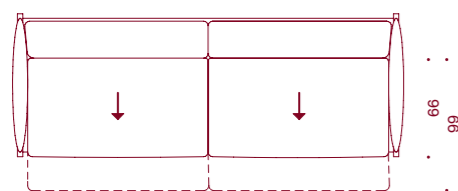

BOSTON



BOSTON

Design by Metrica

Fierezza e solidità, presenza connotante, eleganza senza tempo: Boston riassume nel suo design un'idea di bellezza sobria, dall'aspetto importante. Le linee sono ridotte al minimo, mentre i volumi sono generosi, accoglienti, morbidi e si sviluppano privilegiando l'asse orizzontale, in un ritmo dimensionale che conferisce a Boston il suo stile deciso. Il basamento, costituito da quattro piedi alti 14 cm in metallo brunito, attribuisce invece slancio e leggerezza. Lo schienale può essere in versione liscia o capitonné, realizzato interamente a mano da maestri tappezzieri, secondo l'antica tecnica di imbottitura risalente al XVIII secolo, grande espressione di artigianalità italiana.

Dignified and solid, a connotative presence, timeless elegance: Boston's design encapsulates an idea of restrained beauty, cutting an impressive figure. Lines are pared back to the essential, while volumes are generous, soft and invitingly comfortable, the design favouring the horizontal in a dimensional rhythm that gives Boston its clear-cut style. The base, consisting of four 14 cm-high metal feet in a bronze finish, instead gives a certain slenderness and lightness. The backrest comes in plain or buttoned, produced entirely by hand by master upholsterers according to a time-honoured technique dating back to the 18th century, the epitome of Italian craftsmanship.

BOSTON L 365 H 67 P 260
CON SCHIENALE CAPITONNÉ IN
TESSUTO LARGEUR 11 E PIEDI
IN METALLO BRUNITO, TAVOLINO
ICARO CON PIANO VETRO FUME'
TRASPARENTE E STRUTTURA CROMO,
TAVOLINO **ABACO** LACCATO OPACO
LAVAGNA, COMPOSIZIONE
SPAZIOTECA

BOSTON W 365 H 67 D 260
WITH TUFTED BACK IN LARGEUR 11
FABRIC AND BURNISHED METAL
LEGS, **ICARO** COFFEE TABLE WITH
SMOKET GREY TRANSPARENT GLASS
AND CHROME STRUCTURE, LAVAGNA
MATT LACQUERED **ABACO** SIDE
TABLE, **SPAZIOTECA** COMPOSITION



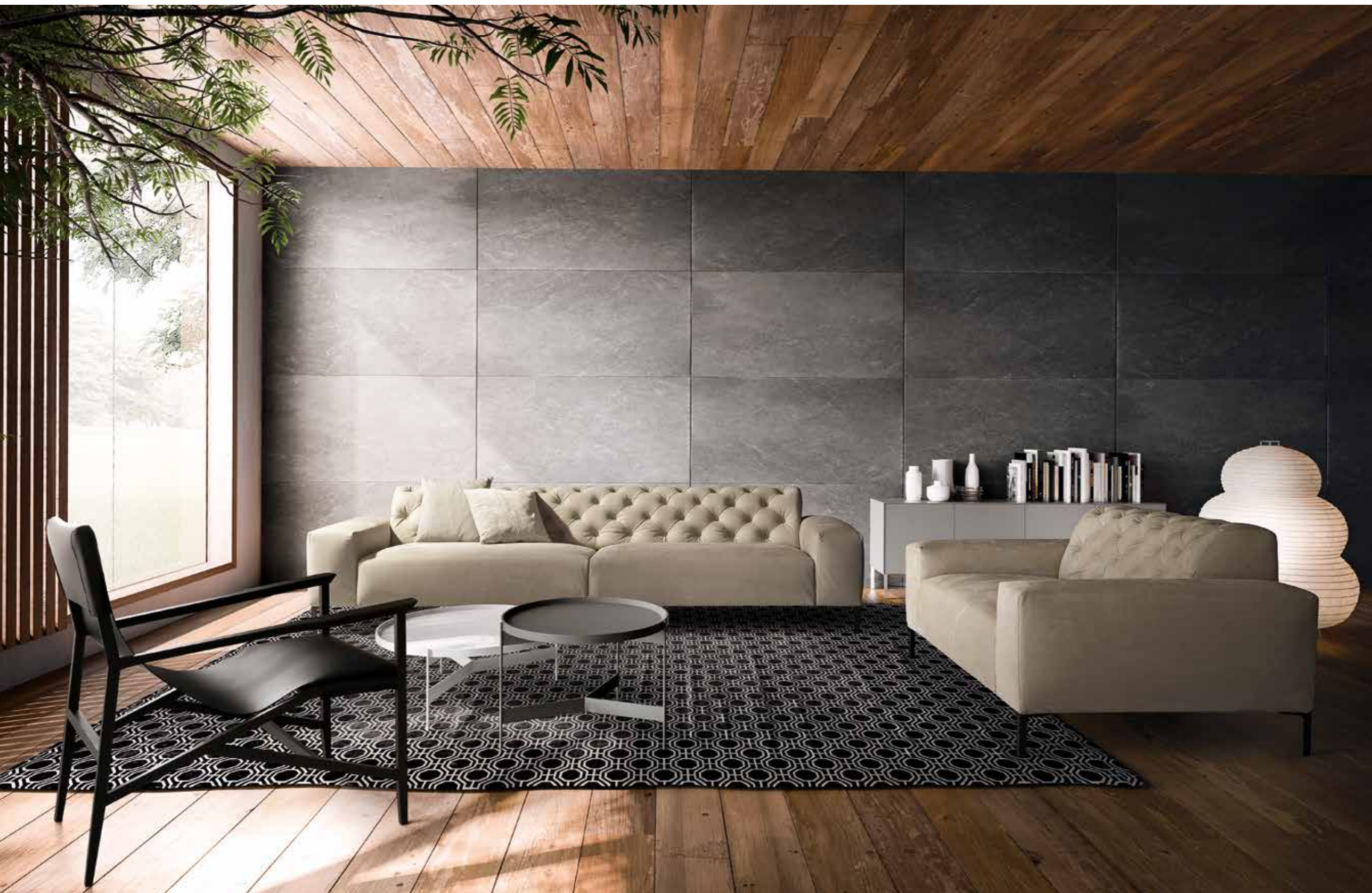

BOSTON L 290 H 67 P 100
E POLTRONA L 170 H 67 P 100 CON
SCHIENALE CAPITONNÉ IN PELLE
NABUK 40 E PIEDI IN METALLO
BRUNITO, POLTRONA **ISOTTA** CON
SEDUTA CUIOIO NERO E STRUTTURA
LACCATO OPACO NERO, TAVOLINI
ABACO LACCATO OPACO BIANCO E
PIOMBO

BOSTON W 290 H 67 D 100
AND ARMCHAIR W 170 H 67 D 100
WITH TUFTED BACK IN NABUK 40
LEATHER AND BURNISHED METAL
LEGS, **ISOTTA** ARMCHAIR WITH
BLACK BELT LEATHER SEAT AND
NERO MATT LACQUERED
STRUCTURE, BIANCO AND PIOMBO
MATT LACQUERED **ABACO** COFFEE
TABLES







BOSTON L 290 H 67 P 100
E POLTRONA L 170 H 67 P 100 CON
SCHIENALE LISCIO IN TESSUTO
SWEET 51 E PIEDI IN METALLO
BRUNITO, TAVOLINI **MONO** LACCATO
OPACO BAMBOO E LAVAGNA,
TAVOLINO **DUETTO** LACCATO OPACO
PIOMBO

BOSTON W 290 H 67 D 100
AND ARMCHAIR W 170 H 67 D 100
WITH PLAIN BACK IN SWEET 51
FABRIC AND BURNISHED METAL
LEGS, BAMBOO AND LAVAGNA MATT
LACQUERED **MONO** COFFEE TABLES,
PIOMBO MATT LACQUERED **DUETTO**
SIDE TABLE



BOSTON L 365 H 67 P 300
CON SCHIENALE LISCIO E POUF
L 120 H 38 P 120 IN TESSUTO RICO
45 E PIEDI IN METALLO BRUNITO,
TAVOLINO **DUETTO** LACCATO OPACO
PIOMBO

BOSTON W 365 H 67 D 300
WITH PLAIN BACK AND OTTOMAN
W 120 H 38 D 120 IN RICO 45 FABRIC
AND BURNISHED METAL LEGS,
PIOMBO MATT LACQUERED **DUETTO**
SIDE TABLE

SCHIENALE LISCIO
PLAIN BACK

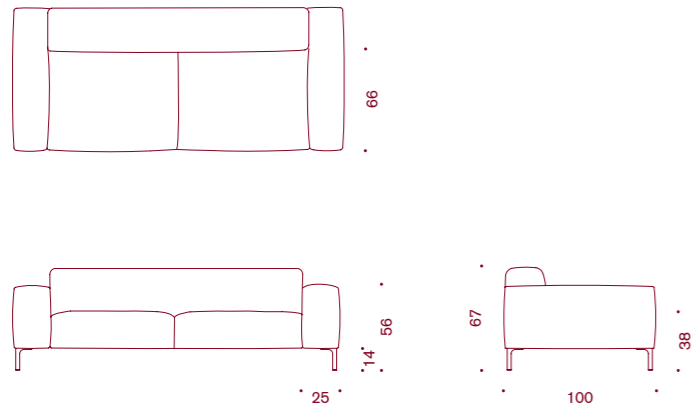

SCHIENALE CAPITONNÉ
TUFTED BACK

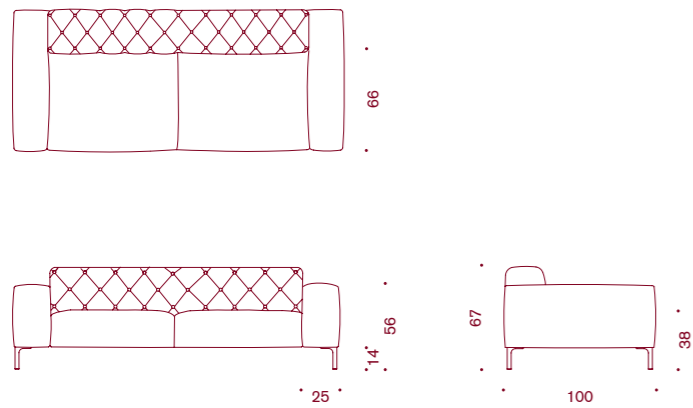

VOLO



VOLO

Leggerezza e grazia, femminile eleganza, studiate sinergie: Volo è espressione di una semplicità che rivela dettagli intriganti e sofisticati. Gli esili piedi in metallo, nelle finiture brill e metallizzate, sollevano Volo come audaci tacchi a spillo, il bracciolo sottile da un fiero slancio, le sedute sono monoscocca, per un design ancora più leggero e minimale. Grande attenzione anche al comfort: i braccioli presentano una leggera bombatura nel lato interno, i cuscini dello schienale sono morbidi ed accoglienti, offrono la possibilità di inserire comodi poggiatesta dalla particolare forma a goccia, liberamente posizionabili.

Lightness and grace, feminine elegance, well thought out synergies: Volo embodies a simplicity that reveals intriguing, sophisticated details.

The slender metal feet in the "brill" finish lift Volo like daring high heels; the slim armrest tapers towards the top for a bold lean look; the seat cushions and carcass are one and the same for an even lighter and more minimal design. Comfort has also been a major focus: armrests are slightly rounded on the inside; the backrest cushions have a soft, sink-in quality, and is designed to accommodate comfortable drop-shaped headrests that can be positioned at will.



VOLO L 250 H 79 P 92
IN TESSUTO RICO 01 E POLTRONE
L 72 H 79 P 86 IN TESSUTO RICO 44
CON PIEDI BRILL, TAVOLINI **MONO**
LACCATO OPACO ARGILLA,
MELANZANA E ZAFFERANO,
COMPOSIZIONE **UNLESS**

VOLO W 250 H 79 D 92
IN RICO 01 FABRIC AND ARMCHAIRS
W 72 H 79 D 86 IN RICO 44 FABRIC
WITH BRILL METAL LEGS, ARGILLA,
MELANZANA AND ZAFFERANO MATT
LACQUERED **MONO** COFFEE TABLES,
UNLESS BOOKCASE



VOLO POLTRONA L 72 H 79 P 86
IN TESSUTO RICO 44 CON
BRACCIOLO SAGOMATO E
PIEDI IN METALLO BRILL

VOLO ARMCHAIRS W 72 H 79 D 86
IN RICO 44 FABRIC WITH SHAPED
ARMREST AND BRILL METAL LEGS

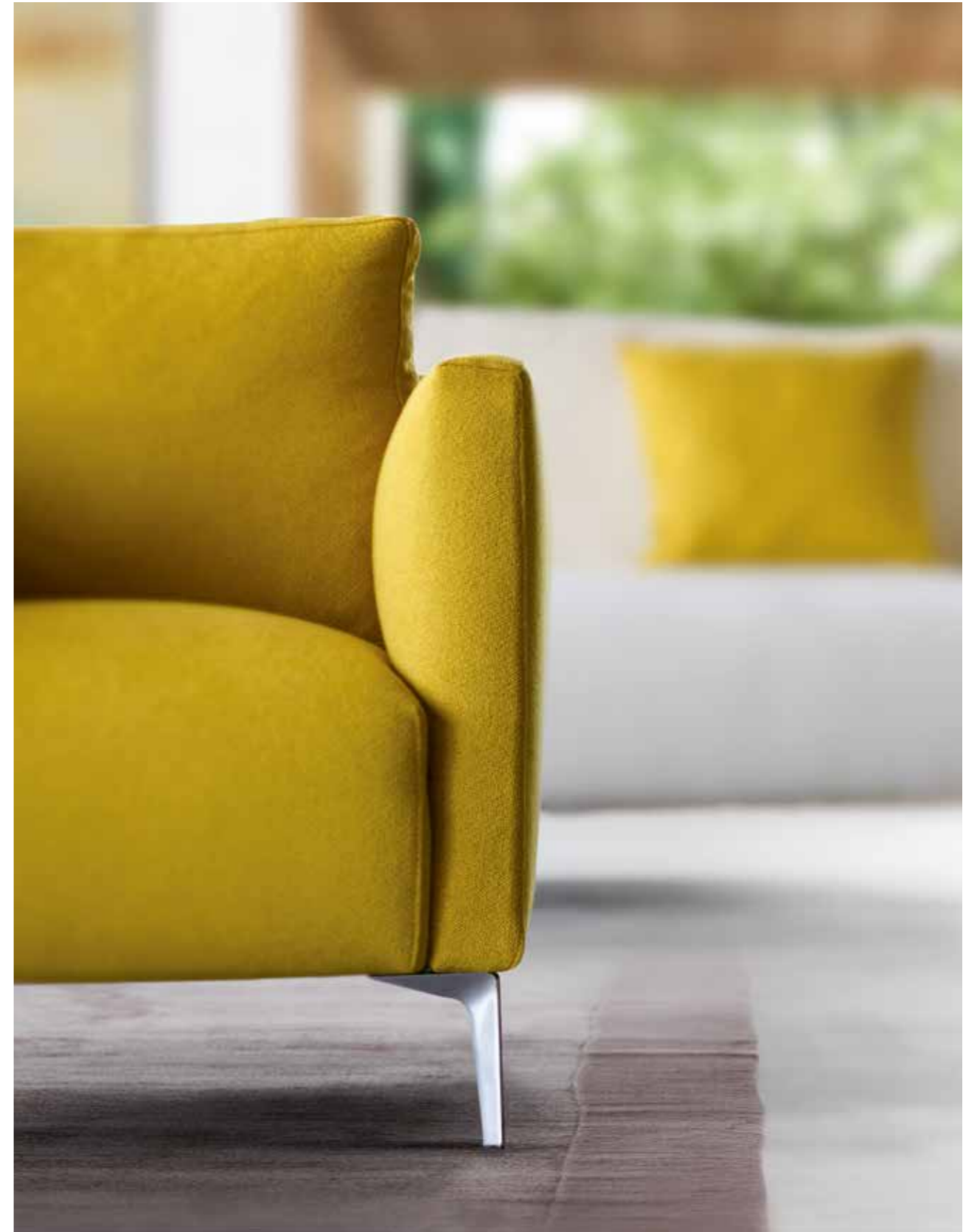



VOLO L 480 H 79 P 332
IN TESSUTO BRENDA 31 CON
PIEDI BRILL, POUF **EDEN** Ø 90 H 40
IN TESSUTO VELVET 51, POLTRONA
DIALOGO IN TESSUTO PERSEO 23,
TAVOLINI **ABACO** LACCATO OPACO
PERLA, NUVOLA E PIOMBO,
COMPOSIZIONE **PEOPLE**

VOLO W 480 H 79 D 332
IN BRENDA 31 FABRIC WITH BRILL
LEGS, **EDEN** OTTOMAN Ø 90 H 40
IN VELVET 51 FABRIC, **DIALOGO**
ARMCHAIR IN PERSEO 23 FABRIC,
PERLA, NUVOLA AND PIOMBO MATT
LACQUERED **ABACO** COFFEE TABLES,
PEOPLE COMPOSITION



VOLO L 332 H 79 P 237 IN TESSUTO RICO 31 E POUF L 92 H 42 P 92 IN TESSUTO VELVET 31 CON PIEDI BRILL, TAVOLINI SERVOQUADRO E 1+1, COMPOSIZIONE SPAZIOTECA | VOLO W 332 H 79 D 237 IN RICO 31 FABRIC AND OTTOMAN L 92 H 42 P 92 IN VELVET 31 FABRIC WITH BRILL METAL LEGS, SERVOQUADRO AND 1+1 COFFEE TABLES, SPAZIOTECA COMPOSITION

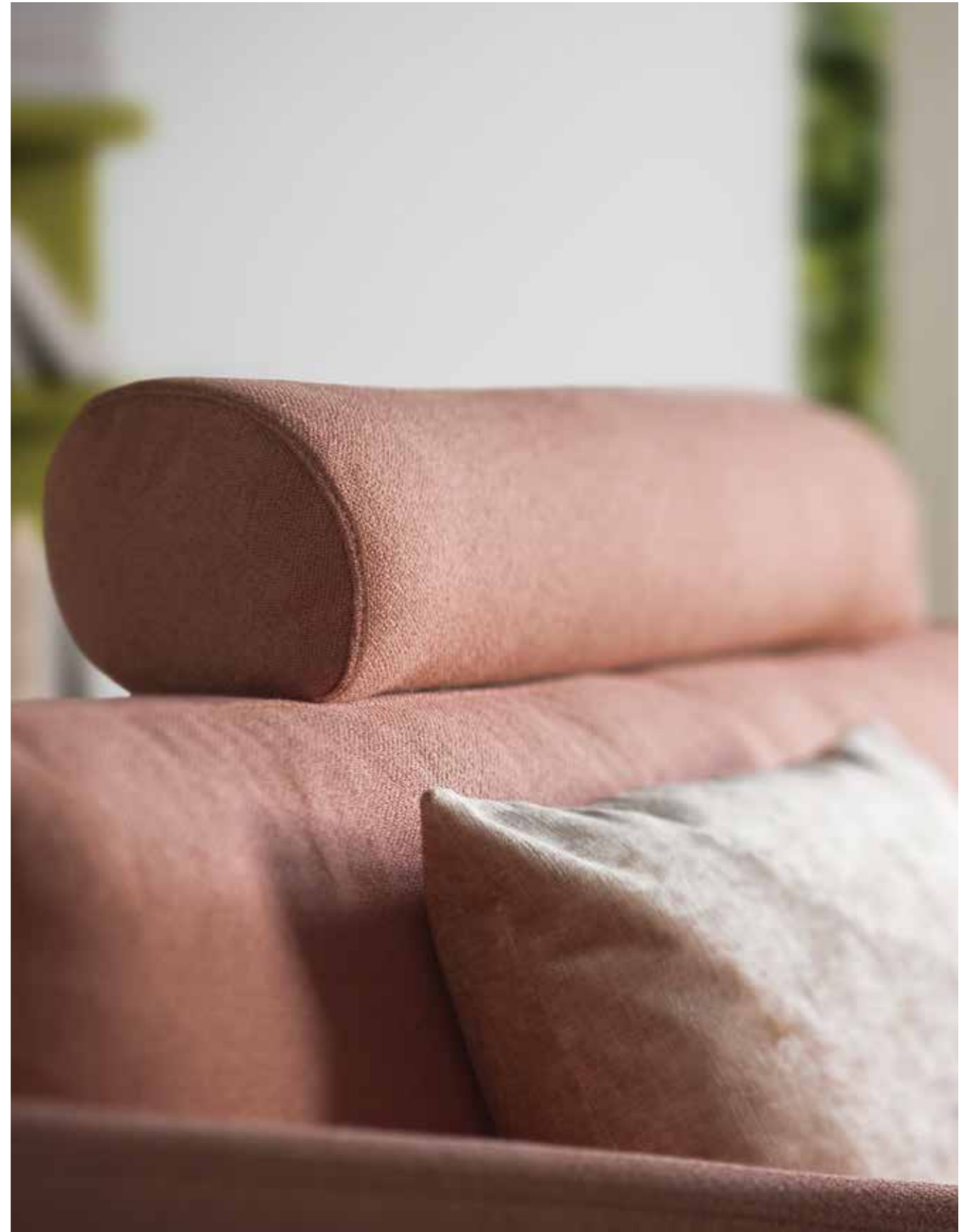
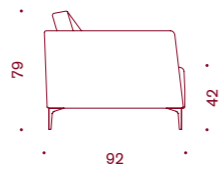
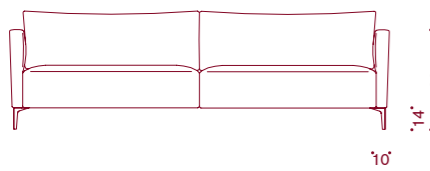
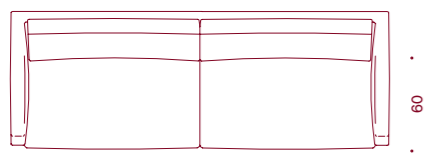

DELANO



DELANO

Forte valore estetico, design sofisticato, massimo comfort: Delano è perfetto come centro stanza, come un'oasi attraente ed accogliente. Un'ampia modularità permette numerosissime e versatili possibilità compositive, arricchite da librerie e tavolini agganciabili lateralmente, realizzabili nei colori laccati e nelle essenze della collezione. Conferisce continuità estetica e strutturale ed è sollevata da terra da piccoli piedi, per un effetto quasi a scomparsa: è la pedana rivestita che alloggia i cuscini di seduta, schienale e braccioli. Le sedute sono studiate per il relax: due altezze e due profondità disponibili, imbottitura morbida, con un sottile strato di piuma.

Strong aesthetic value, sophisticated design, unbeatable comfort: Delano is perfect set in the middle of a room, an attractive, welcoming oasis. With plenty of modules to choose from, you can put together endless versatile seating configurations, adding the finishing touch with bookcases and side tables that fit on the sides, available in any of the collection's lacquered colours or wood finishes. It delivers an aesthetic and structural continuity and is raised off the floor on little feet for an almost invisible floating effect: the seat, backrest and armrest cushions sit on the upholstered platform. The seating has been designed for relaxing: it comes in two heights and two depths, with soft padding including a thin layer of down.



DELANO L 462 H 75 P 99
IN PELLE SOFTY 61, TAVOLINI
ANTONIETTA NERO

DELANO W 462 H 75 D 99
IN SOFTY 61 LEATHER, NERO
ANTONIETTA SIDE TABLES





DELANO L 528 H 60-75 P 363
IN TESSUTO ALFA 01, TAVOLINO 1+1
LACCATO OPACO FUMO E TAVOLINI
MONO LACCATO OPACO BIANCO E
ARGILLA, COMPOSIZIONE SPAZIOTECA

DELANO W 528 H 60-75 D 363
IN ALFA 01 FABRIC, FUMO MATT
LACQUERED 1+1 SIDE TABLE,
BIANCO AND ARGILLA MATT
LACQUERED MONO COFFEE TABLES,
SPAZIOTECA COMPOSITION



DELANO L 330 H 60 P 132 E POUF L 99 H 39 P 99 IN TESSUTO LARGEUR 42, TAVOLINI ABACO LACCATO OPACO LAVAGNA
DELANO W 330 H 60 D 132 AND OTTOMAN W 99 H 39 D 99 IN LARGEUR 42 FABRIC, LAVAGNA MATT LACQUERED ABACO COFFEE TABLES





DELANO L 396 H 75 P 330
IN TESSUTO BRENDA 12 CON
LIBRERIA ROVERE GRIGIO,
TAVOLO SOFFIO, SEDIE ESSE

DELANO W 396 H 75 D 330
IN BRENDA 12 FABRIC WITH
GREY OAK BOOKCASE, SOFFIO
TABLE, ESSE CHAIRS

LIBRERIA USO BRACCIOLO H 56
BOOKCASE USED AS ARMREST H 56

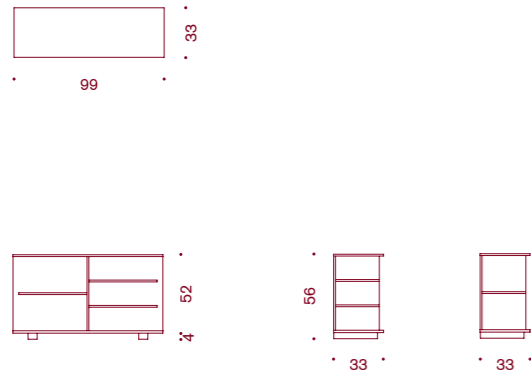

TAVOLINO LIBRERIA USO BRACCIOLO H 56
BOOKCASE SIDE TABLE USED AS ARMREST H 56

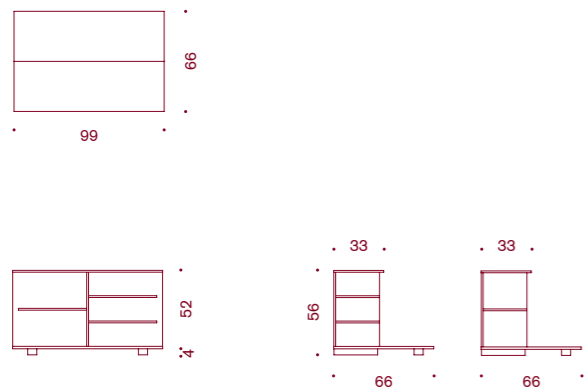

TAVOLINO H 6
SIDE TABLE H 6

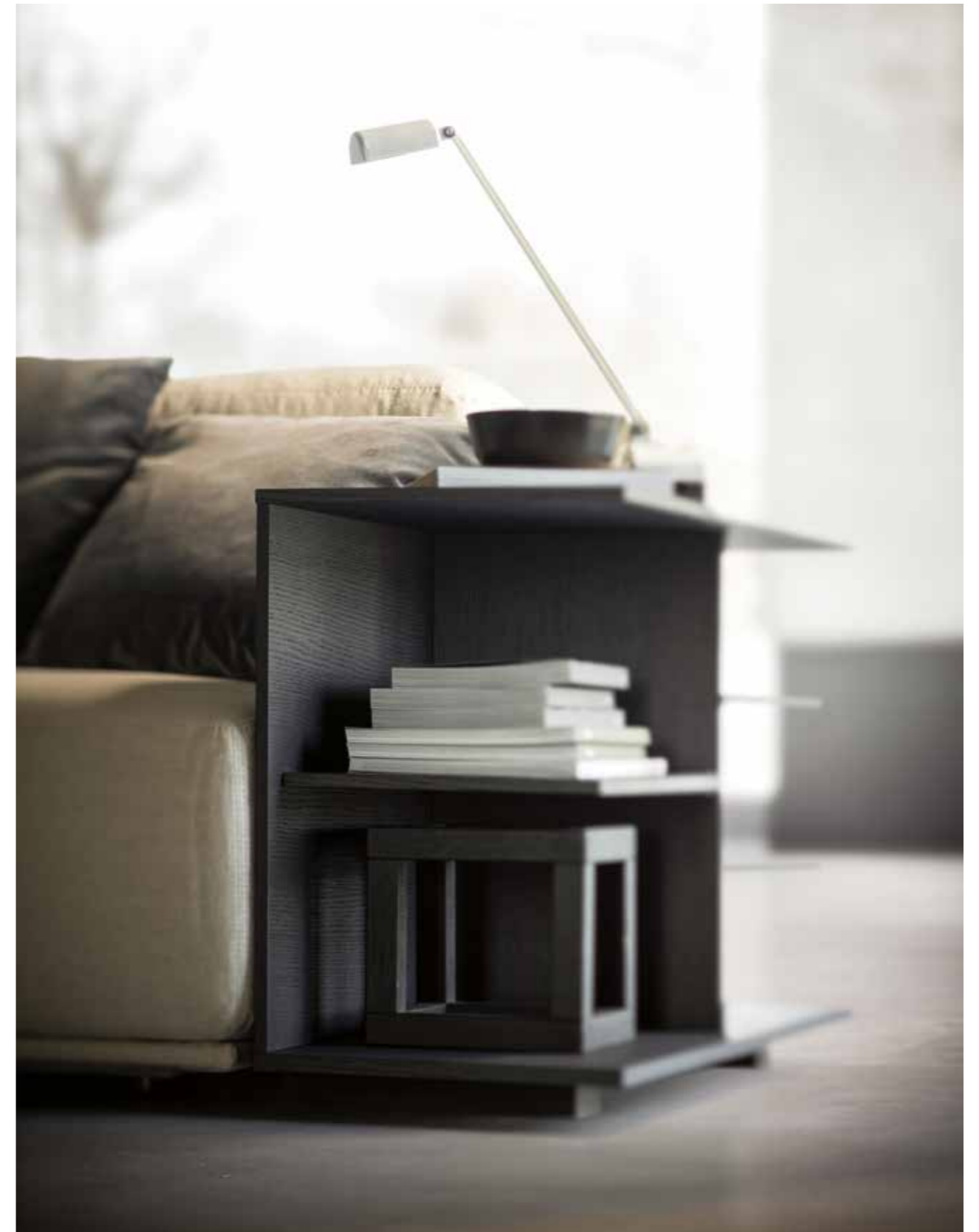
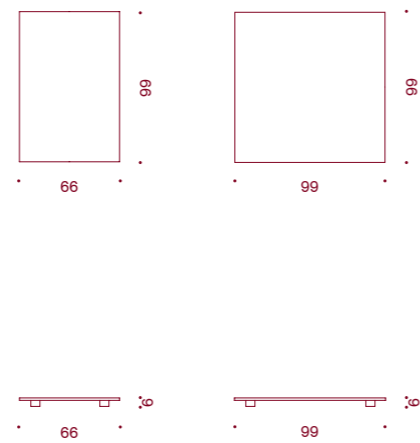

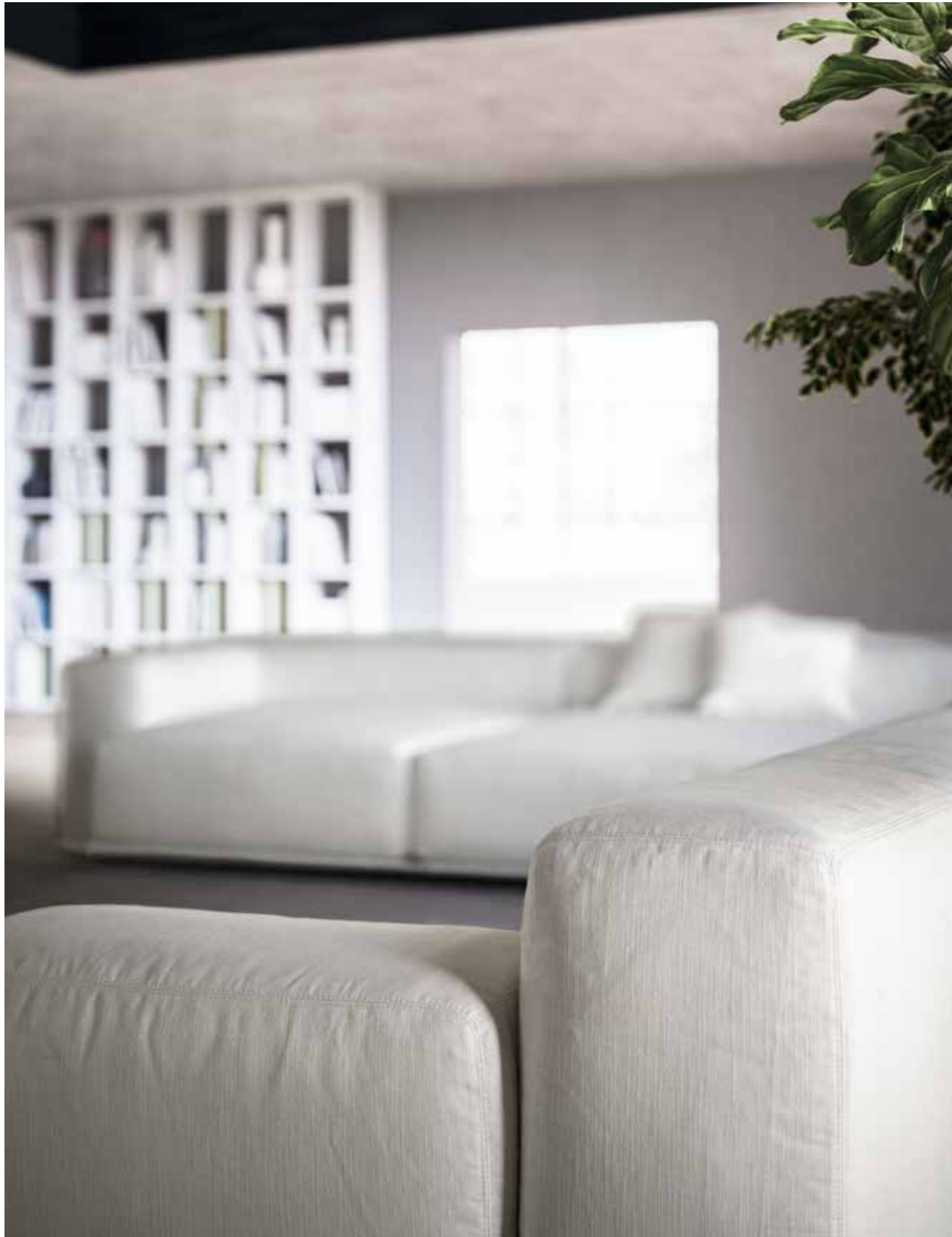

SCHIENALE BASSO
LOW BACK

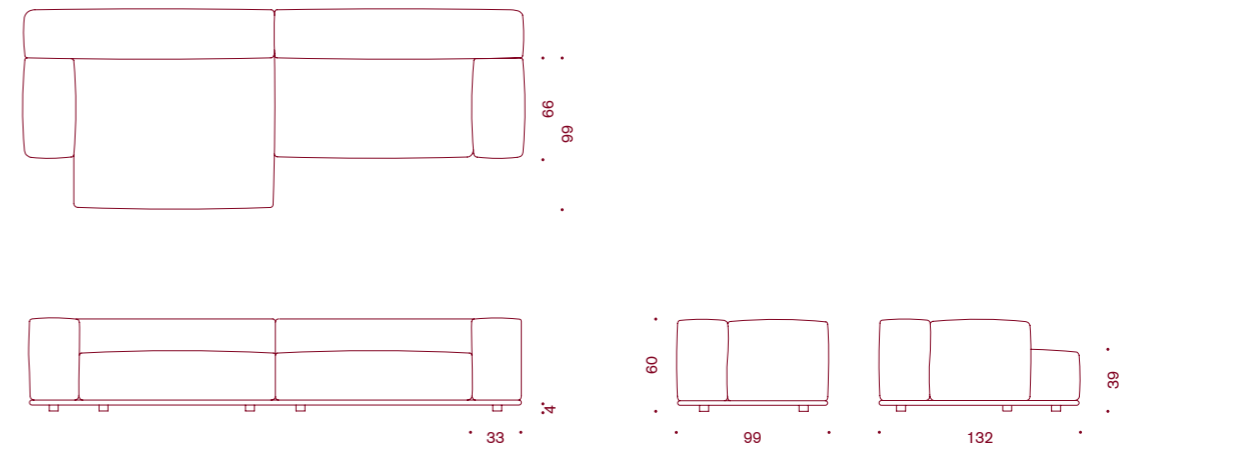

SCHIENALE ALTO
HIGH BACK

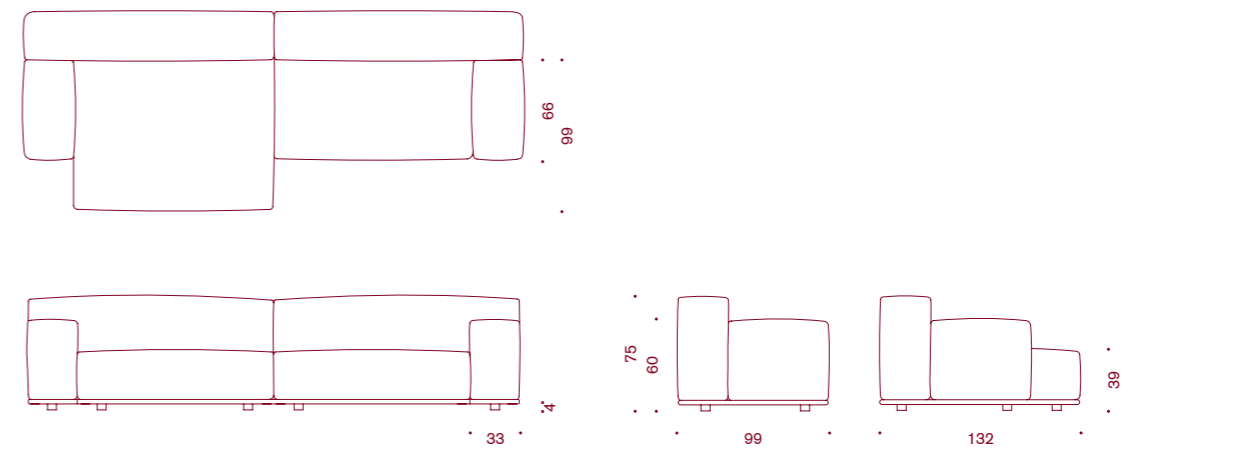

NEWPORT



NEWPORT

Design by Metrica

Forme essenziali e raffinate, molteplici soluzioni funzionali, configurazioni spaziali moderne ed originali: Newport è un progetto poliedrico, componibile ed ampiamente personalizzabile in base a specifiche necessità e preferenze. Ideale come isola, per connettere o suddividere spazi diversi, Newport è integrabile con sottili pannelli boiserie, rivestiti in tessuto o pelle, ed associabile ad una vasta gamma di accessori: arredi multiuso, piani con funzione scrittoio, elementi passanti uso libreria, moduli contenitivi dotati di sistema wire-manager, per la ricarica di apparecchi digitali, e passacavi.

Refined, understated shapes, functional solutions, original modern spatial configurations: Newport is a highly versatile, sectional design that offers extensive options for tailoring to individual needs and preferences. Ideal as a seating island, to connect or divide different spaces, Newport can be integrated with slim wall panelling, covered in fabric or leather, and teamed with a vast range of accessories: multi-purpose units, surfaces serving as desks, open-back units for books, storage modules with wire-management system for charging digital devices, and wiring grommets with hinged covers.

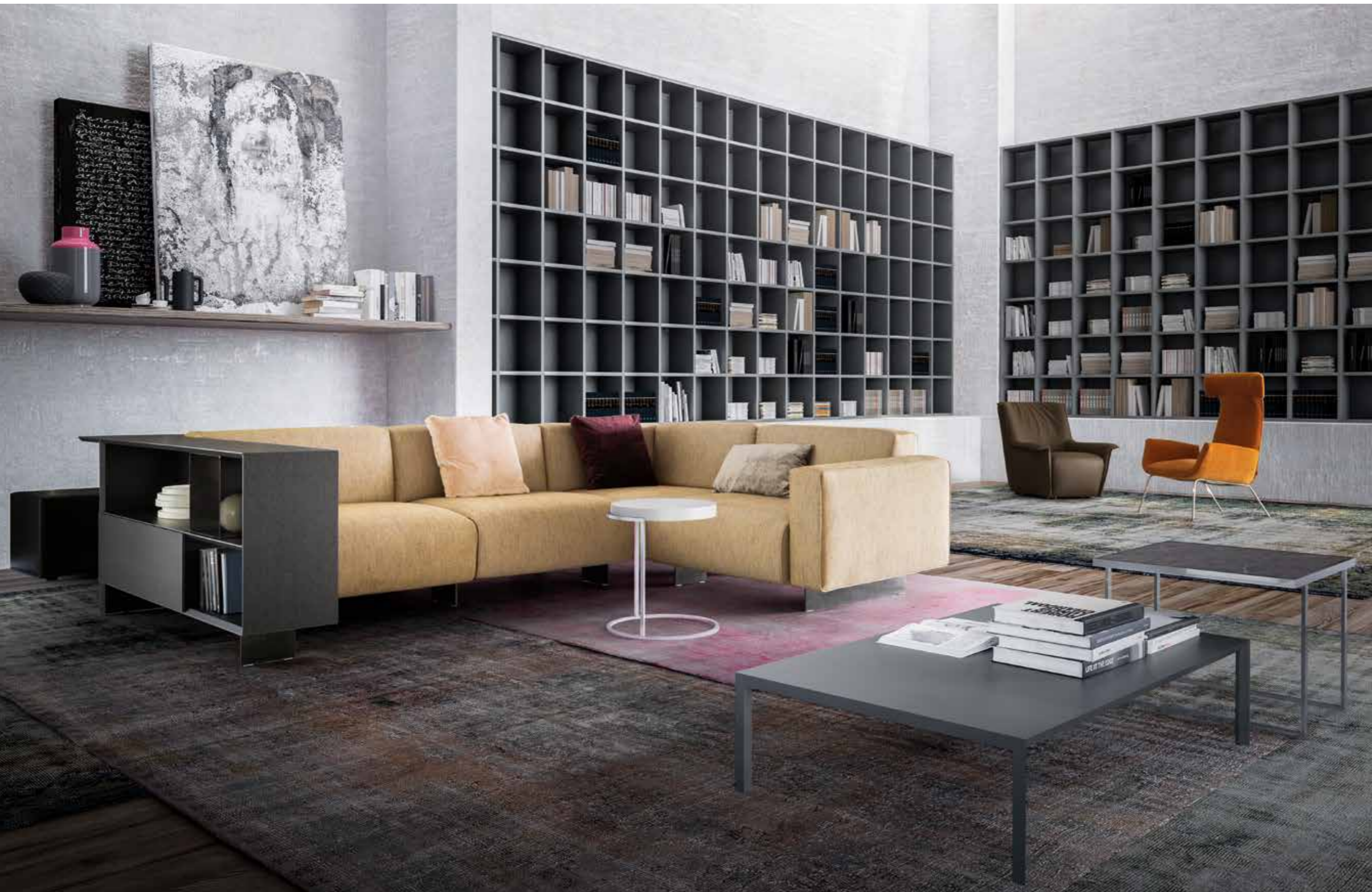

NEWPORT L 310 H 77 P 238
IN TESSUTO TAIGAL 43, LIBRERIA
CON WORK TOP ROVERE GRIGIO
E LACCATO OPACO LAVAGNA,
BASAMENTO TITANIO, TAVOLINI
SERVOGIRO, MONO E ICARO,
POLTRONE **DORA E DIALOGO,**
COMPOSIZIONE **SPAZIOTECA**

NEWPORT W 310 H 77 D 238
IN TAIGAL 43 FABRIC, GREY OAK
AND LAVAGNA MATT LACQUERED
BOOKCASE WITH DESK, TITANIUM
BASE, **SERVOGIRO, MONO AND**
ICARO COFFEE TABLES, **DORA AND**
DIALOGO ARMCHAIRS, **SPAZIOTECA**
COMPOSITION

NEWPORT IN TESSUTO TAIGAL 43,
LIBRERIA CON WORK TOP ROVERE
GRIGIO E LACCATO OPACO LAVAGNA

NEWPORT IN TAIGAL 43 FABRIC.
GREY OAK AND LAVAGNA MATT
LACQUERED BOOKCASE WITH DESK

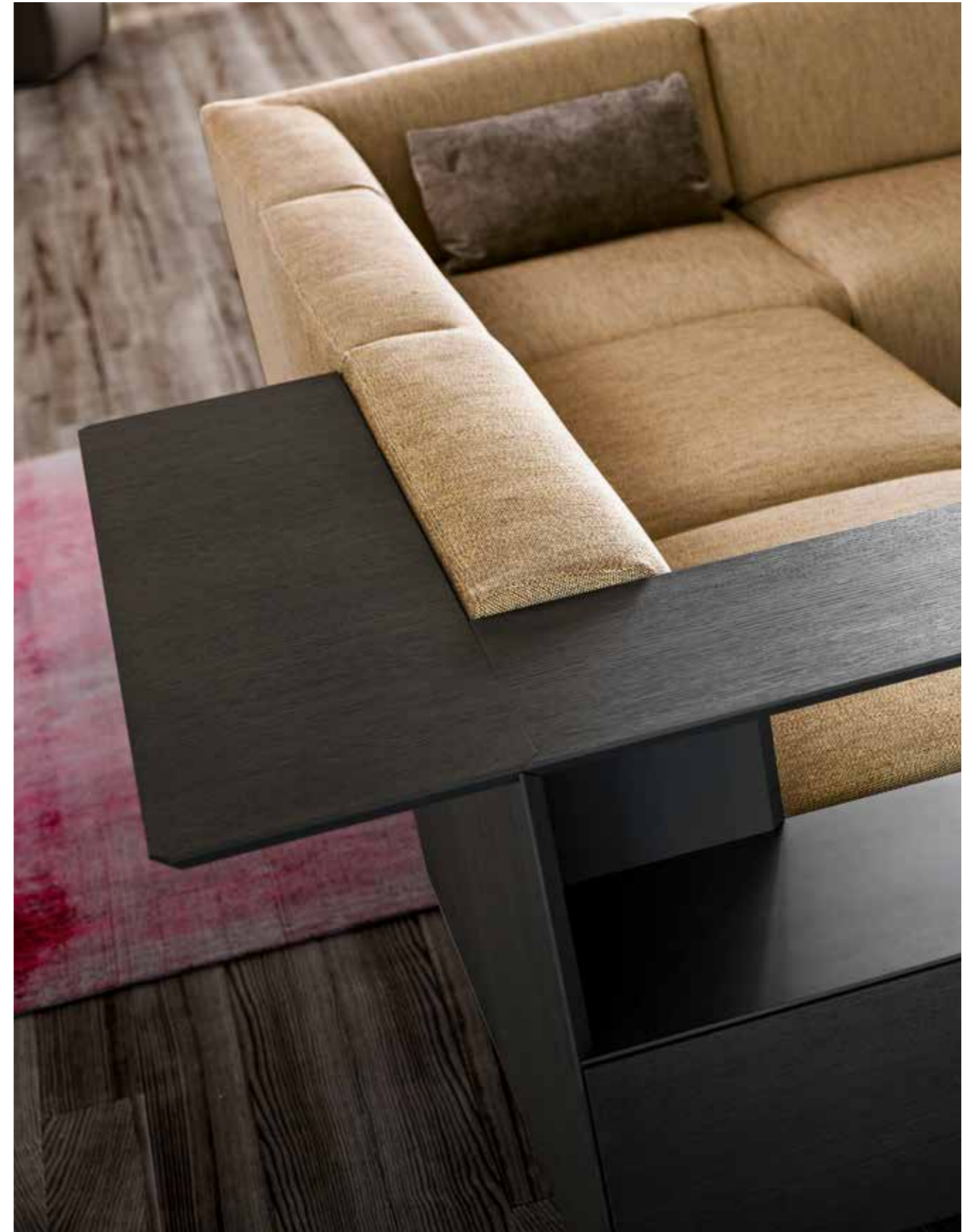



NEWPORT L 307 H 67-112 P 204
IN TESSUTO RICO 41, LIBRERIA
H 75 LACCATO OPACO CAPPUCCINO,
BOISERIE IN TESSUTO LARGEUR 21,
BASAMENTO TITANIO, POUF **EDEN**
IN TESSUTO VELVET 41, POLTRONA
DIALOGO IN PELLE LORD 87

NEWPORT W 307 H 67-112 D 204
IN RICO 41 FABRIC, CAPPUCCINO
MATT LACQUERED BOOKCASE H 75,
PANELS IN LARGEUR 21 FABRIC,
TITANIUM BASE, **EDEN** OTTOMAN
IN VELVET 41 FABRIC, **DIALOGO**
ARMCHAIR IN LORD 87 LEATHER





NEWPORT L 340 H 55-112 P 153
IN TESSUTO POSITANO 11,
LIBRERIA CON MODULO ESTRAIBILE
BORGOGNA E LACCATO OPACO RAL
3010, BOISERIE IN PELLE VINTAGE 61,
BASAMENTO BRONZO, TAVOLINI
ICARO CON PIANO IN MARMO OPACO
EMPERADOR, CARRARA GIOIA E
STRUTTURA CROMO

NEWPORT W 340 H 55-112 D 153 IN
POSITANO 11 FABRIC, BURNT OAK
AND RAL 3010 MATT LACQUERED
BOOKCASE WITH DRAWER MODULE,
PANELS IN VINTAGE 61 LEATHER,
BRONZE BASE, **ICARO** COFFEE TABLE
WITH MATT EMPERADOR, CARRARA
GIOIA MARBLE TOP AND CHROME
STRUCTURE





LIBRERIA CON MODULO ESTRAIBILE H 55
BOOKCASE WITH PULLOUT MODULE H 55

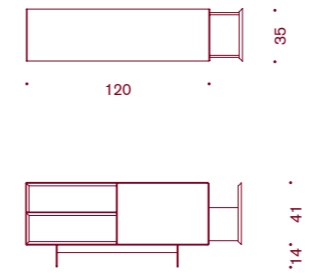

LIBRERIA H 65 E H 75
BOOKCASE H 65 AND H 75

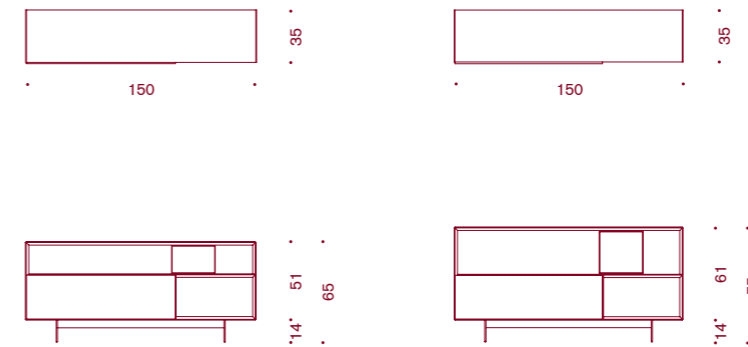

LIBRERIA CON WORK TOP H 75
BOOKCASE WITH DESK H 75

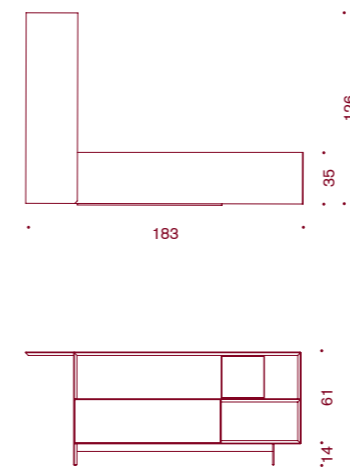

BOISERIE H 112
PANELS H 112

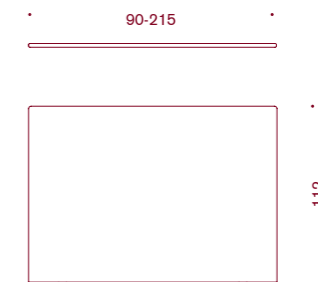

SCHIENALE BASSO
LOW BACK

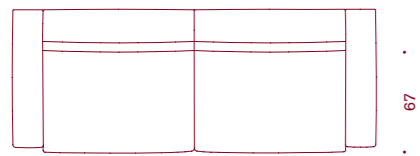

67

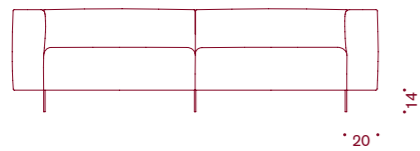

20

14

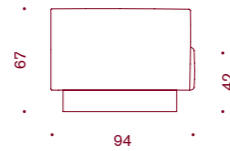

67

94

42

SCHIENALE ALTO
HIGH BACK

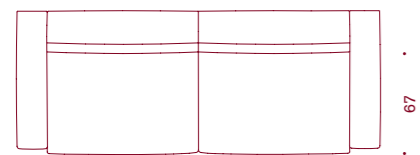

67

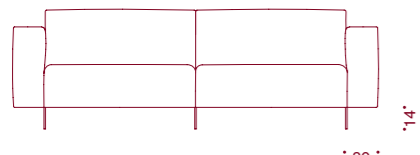

20

14

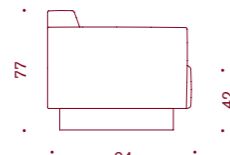

77

94

42



TIME



TIME

Iconico, raffinato, orgogliosamente elegante: Time rappresenta il divano per antonomasia. Linee, volumi, proporzioni sono perfettamente accordati tra loro in un complesso armonico di chiara e semplice leggibilità. La struttura è scandita da dimensioni ripetute e da forme avvolgenti: il bracciolo è inclinato e bombato verso l'interno e gira, mantenendo altezza e spessore nello schienale, sul quale poggiano cuscini lisci o trapuntati, per una versione più moderna o più classica. Per aumentare il comfort sono inseribili comodi poggiatesta. Disponibile nelle essenze e nei colori della collezione, il basamento aggiunge un tocco di personalizzazione.

Iconic, refined, proudly elegant: Time is the ultimate sofa. Lines, volumes and proportions all complement each other perfectly, creating a harmonious and clearly, plainly legible whole. Repeated dimensions and enveloping shapes dictate the structure's rhythm: the slanted armrest is rounded on the inside and, maintaining height and thickness, bends round to form the backrest supporting plain or tufted cushions, depending on whether you're going for a modern or more classic look. Comfortable headrests can be inserted for added comfort. Available in any of the collection's wood finishes or colours, the basement add a personalized touch.

TIME L 228 H 86 P 96
CON SCHIENALE LISCIO IN
TESSUTO AMALFI 31 E BASAMENTO
ROVERE GRIGIO, TAVOLINI **MONO**
LACCATO OPACO BIANCO E
MELOGRANO, COMPOSIZIONE
UNLESS

TIME W 228 H 86 D 96
WITH PLAIN BACK IN AMALFI 31
FABRIC AND GREY OAK BASE,
BIANCO AND MELOGRANO MATT
LACQUERED **MONO** COFFEE
TABLES, **UNLESS** BOOKCASE





TIME L 356 H 86 P 334
CON SCHIENALE LISCIO IN
TESSUTO BRENDA 01 E POLTRONE
L 92 H 84 P 86 IN TESSUTO VELVET 33
CON BASAMENTO LACCATO OPACO
ARGILLA, TAVOLINI **ABACO** LACCATO
OPACO PERLA

TIME W 356 H 86 D 334
WITH PLAIN BACK IN BRENDA 01
FABRIC AND ARMCHAIRS
W 92 H 84 D 86 IN VELVET 33 FABRIC
WITH ARGILLA MATT LACQUERED
BASE, PERLA MATT LACQUERED
ABACO COFFEE TABLES

TIME L 334 H 86 P 226
CON SCHIENALE TRAPUNTATO IN
TESSUTO PENNY 41 E BASAMENTO
LACCATO OPACO ARGILLA

TIME W 334 H 86 D 226
WITH TUFTED BACK IN PENNY 41
FABRIC AND ARGILLA MATT
LACQUERD BASE





TIME L 334 H 86 P 226 CON SCHIENALE TRAPUNTATO IN TESSUTO PENNY 41 E BASAMENTO LACCATO OPACO ARGILLA,
POUF TIME L 96 H 45 P 96 IN TESSUTO PERSEO 23 CON PIEDI BORGOGNA, TAVOLINI ABACO E SERVOGIRO
TIME W 334 H 86 D 226 WITH TUFTED BACK IN PENNY 41 FABRIC AND ARGILLA MATT LACQUERD BASE,
TIME OTTOMAN W 96 H 45 D 96 IN PERSEO 23 FABRIC WITH BURNT OAK LEGS, ABACO AND SERVOGIRO COFFEE TABLES



TIME L 326 H 86 P 96
CON SCHIENALE TRAPUNTATO IN
TESSUTO VELVET 41 E POUF
L 96 H 45 P 96 IN TESSUTO PERSEO
23 CON BASAMENTO BORGOGNA,
POLTRONE **OPLÀ** IN TESSUTO VELVET
31, TAVOLINI **ABACO** LACCATO
OPACO PIOMBO E ZAFFERANO

TIME W 326 H 86 D 96
WITH TUFTED BACK IN VELVET 41
FABRIC AND OTTOMAN W 96 H 45 D 96
IN PERSEO 23 FABRIC WITH BURNT
OAK BASE, **OPLÀ** ARMCHAIRS IN
VELVET 31 FABRIC, PIOMBO AND
ZAFFERANO MATT LACQUERED
ABACO COFFEE TABLES

SCHIENALE LISCIO
PLAIN BACK

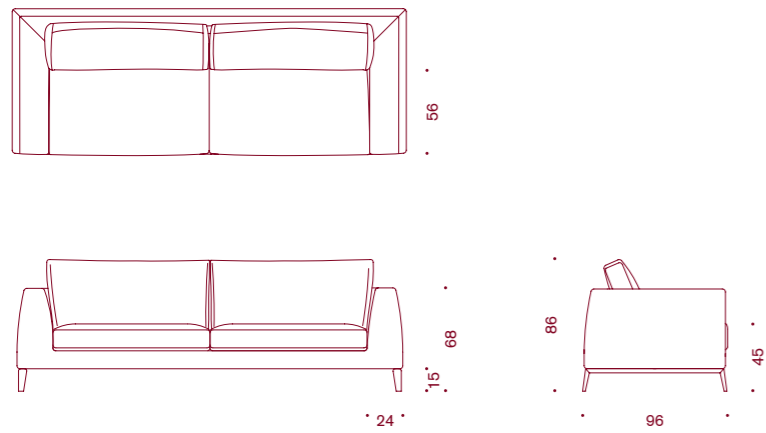

SCHIENALE TRAPUNTATO
TUFTED BACK

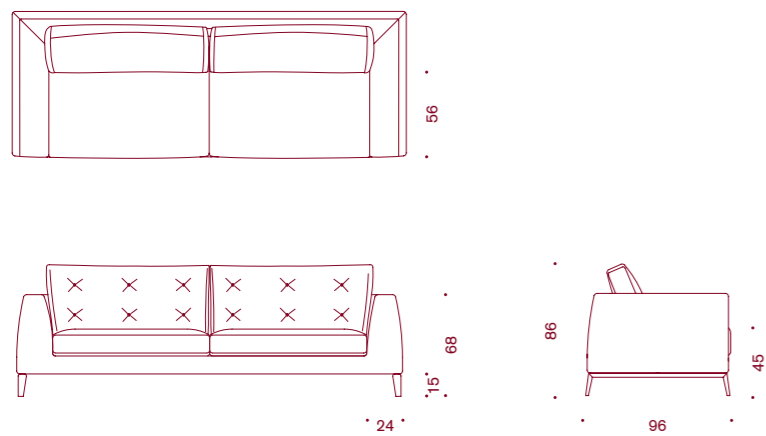

EDEN



EDEN

Leggero come una nuvola, moderno ed anticonvenzionale: Eden si distingue per il suo carattere giocoso ed informale. Fuori dagli schemi la scelta di rinunciare a struttura e base rigidi, a favore di un'imbottitura in poliuretano espanso e di una base in tessuto tecnico, che poggia direttamente a terra, migliorandone l'aderenza. Originale anche il sistema di componibilità, basato su cerniere e cinghie che consentono di connettere con semplicità i vari elementi. Ad impreziosire e definire le morbide forme di Eden, un bordino in tessuto corre lungo tutto il suo perimetro. I pouf sono disponibili anche in versione trapuntata.

As light as a cloud, modern and unconventional: Eden stands out for its playful, casual character. Breaking with tradition, the design does away with a rigid frame and base in favour of expanded polyurethane padding and a technical fabric base sitting directly on the floor for better grip. The modular system is just as original with its use of a supremely simple combination of zips and straps to join the various modules together. Piping along all the outer edges embellishes Eden's soft shapes and gives them greater definition. The ottomans also come in a tufted version.

EDEN L 313 H 73 P 90
IN TESSUTO SWEET 43, POUF IN
TESSUTO SWEET 43 E VELVET 33,
TAVOLINI **ABACO** LACCATO
OPACO PIOMBO

EDEN W 313 H 73 D 90
IN SWEET 43 FABRIC, OTTOMANS
IN SWEET 43 AND VELVET 33 FABRIC,
PIOMBO MATT LACQUERED **ABACO**
COFFEE TABLES





EDEN L 83 H 73 P 90
E POUF L 83 H 40 P 58 IN TESSUTO
POSITANO 31, TAVOLINI ANTONIETTA

EDEN W 83 H 73 D 90
AND OTTOMANS W 83 H 40 D 58
IN POSITANO 31 FABRIC, ANTONIETTA
SIDE TABLES





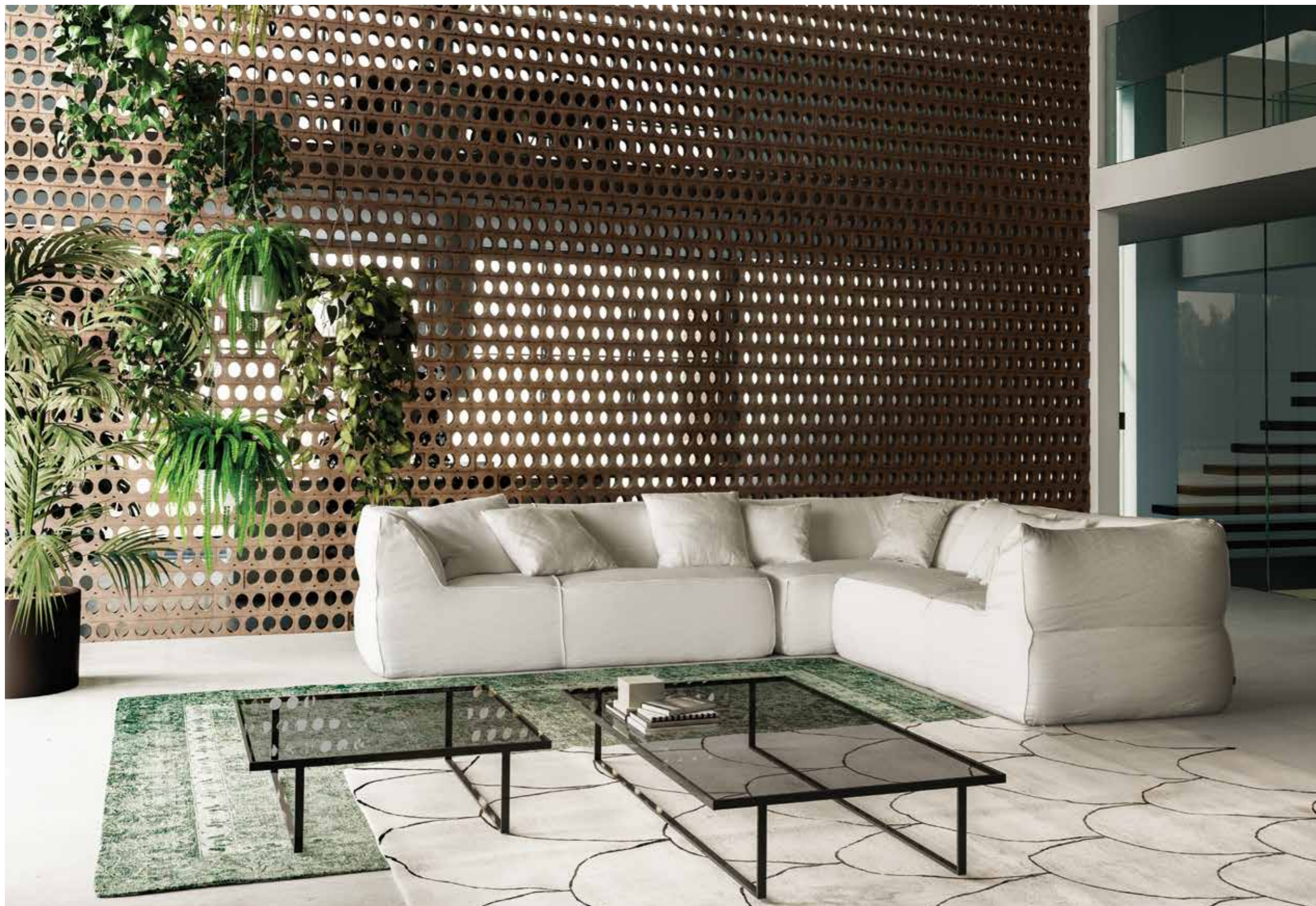

EDEN L 288 H 73 P 313
IN TESSUTO SHABBY UNITO 02,
TAVOLINI ICARO CON PIANO VETRO
FUMÈ TRASPARENTE E STRUTTURA
TITANIO

EDEN W 288 H 73 D 313
IN SHABBY UNITO 02 FABRIC,
ICARO COFFEE TABLES WITH
TRANSPARENT SMOKEY GREY
GLASS AND TITANIUM STRUCTURE

EDEN CHAISE LONGUE
L 83 H 73 P 160 IN PELLE SINTETICA
TRANZERELLE 71, TAVOLINO **ABACO**
LACCATO OPACO PIOMBO

EDEN CHAISE LONGUE
W 83 H 73 D 160 IN TRANZERELLE 71
SYNTHETIC LEATHER, PIOMBO MATT
LACQUERED **ABACO** COFFEE TABLE

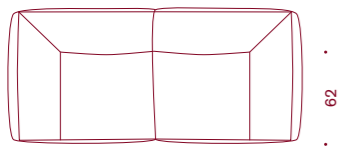

62

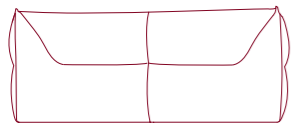

32

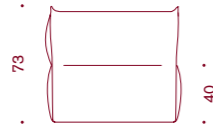

73

90

40



PALIO



PALIO

Affascinante presenza, carattere deciso, stile sofisticato: Palio è sinonimo di classe ed eleganza. I suoi volumi sono ampi, ben scanditi da un design lineare e raffinato. L'altezza dello schienale è a filo con i braccioli, caratterizzati da dimensioni generose e confortevoli. La composizione dello schienale prevede, a scelta, due differenti possibilità: cuscini larghi come le sedute, oppure più stretti e alti, sostenuti in questo caso da rulli cilindrici progettati ad hoc. I piedi, a sezione rettangolare, terminano con una lamina, fissata in corrispondenza dei braccioli. Sono proposti con finitura cromata o metallizzata.

Captivating presence, resolute character, sophisticated style: Palio is synonymous with class and elegance. Its generous volumes are set off beautifully by a refined, linear design. The top of the backrest sits flush with the generously and comfortably sized armrests. The backrest offers a choice of two different arrangements: cushions the same width as the seat cushions; or narrower, taller cushions, in this case propped up against purpose-made cylindrical rolls. The feet, with a rectangular section, end in a blade, which is fastened under the armrests. They come with a chrome or metallic finish.



PALIO L 260 H 91 P 107
CON SCHIENALE ALTO E RULLO IN
TESSUTO TAIGAL 43 E PIEDI ORO,
POLTRONE **DORA** IN TESSUTO RICO
44 CON BASAMENTO VERNICIATO
LAVAGNA, TAVOLINI **SERVOGIRO** E
ICARO, COMPOSIZIONE **PEOPLE**

PALIO W 260 H 91 D 107
WITH HIGH BACK AND ROLL
CUSHION IN TAIGAL 43 FABRIC,
GOLD LEGS, **DORA** ARMCHAIR IN
RICO 44 FABRIC WITH LAVAGNA
LACQUERED BASE, **SERVOGIRO** AND
ICARO COFFEE TABLES, **PEOPLE**
COMPOSITION





PALIO L 362 H 84 P 424
CON SCHIENALE BASSO IN TESSUTO
PERSEO 01 E PIEDI LACCATO
OPACO LAVAGNA, TAVOLINO **ABACO**
LACCATO OPACO BIANCO, TAVOLINO
HAIK ORO, COMPOSIZIONE **PEOPLE**

PALIO W 362 H 84 D 424
WITH LOW BACK IN PERSEO
01 FABRIC AND LAVAGNA MATT
LACQUERED LEGS, BIANCO MATT
LACQUERED **ABACO** COFFEE TABLE,
GOLD **HAIK** COFFEE TABLE, **PEOPLE**
COMPOSITION



PALIO L 320 H 91 P 155 CON SCHIENALE ALTO E RULLO IN PELLE SOFTY 62, PIEDI BRONZO,
POUF EDEN Ø 90 H 40 IN TESSUTO SWEET 42, TAVOLINI ABACO LACCATO OPACO NINFEA E MELANZANA
PALIO W 320 H 91 D 155 WITH HIGH BACK AND ROLL CUSHION IN SOFTY 62 LEATHER, BRONZE LEGS,
EDEN OTTOMAN Ø 90 H 40 IN SWEET 42 FABRIC, NINFEA AND MELANZANA MATT LACQUERED ABACO COFFEE TABLES



PALIO L 260 H 84 P 107
CON SCHIENALE BASSO IN
TESSUTO VELVET 53, L 230 H 84
P 107 IN TESSUTO RICO 22 E PIEDI
TITANIO, TAVOLINI ANTONIETTA
NERO E ROSSO, MADIE GINEVRA

PALIO W 260 H 84 D 107
WITH LOW BACK IN VELVET 53
FABRIC, W 230 H 84 D 107 IN RICO 22
FABRIC AND TITANIUM LEGS, BLACK
AND RED ANTONIETTA COFFEE
TABLES, GINEVRA SIDEBOARDS

SCHIENALE BASSO
LOW BACK

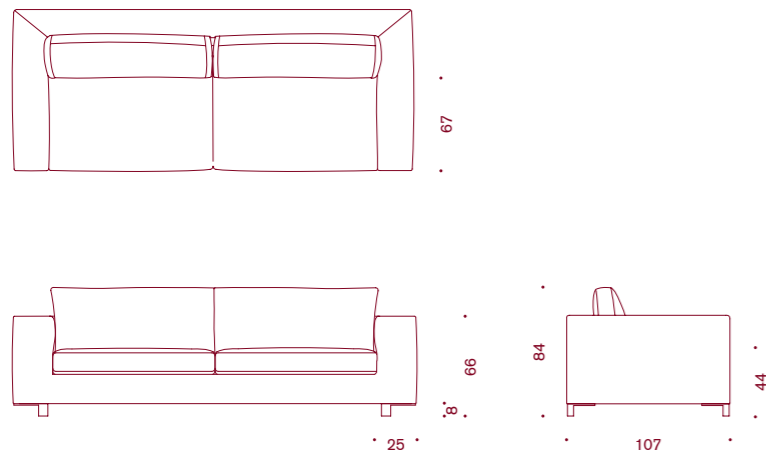

SCHIENALE ALTO CON RULLO
HIGH BACK WITH HEAD REST

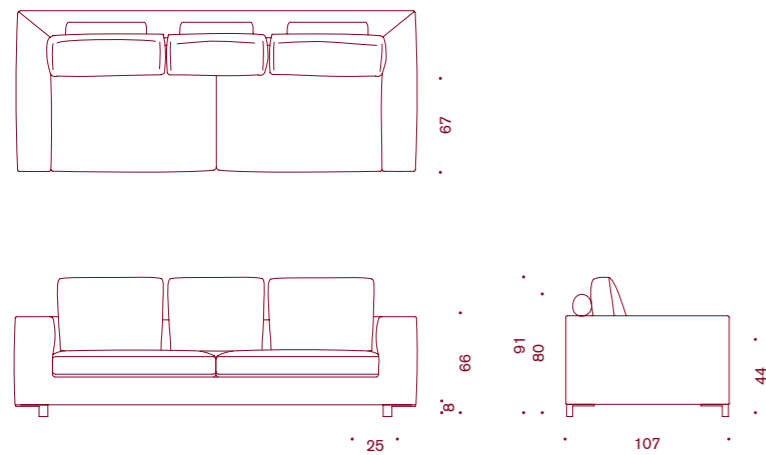

MOOD



MOOD

Discreto e versatile, Mood mette d'accordo tutti con il suo design ispirato al divano tradizionale. La struttura è semplice e lineare, i rapporti dimensionali si ripetono e donano armonia all'insieme. Un tocco di eccentricità è dato dal bracciolo, che va assottigliandosi verso l'alto, assumendo una particolare forma trapezoidale. Gli ampi ed accoglienti cuscini dello schienale possono essere accessorati con comodi rulli poggiatesta. La scocca su cui poggiano i cuscini della seduta permette di ospitare i meccanismi di rete per il letto estraibile.

Discreet and versatile, Mood is an all-round crowd pleaser with its design inspired by the traditional sofa. It has a simple, linear frame and its dimensional ratios are repeated throughout, giving an overall harmonious look. Adding a touch of eccentricity, the armrest tapers towards the top, resulting in a distinctive trapezoidal shape. The large, cosy backrest cushions can be accessorized with comfortable roll headrests. The carcass the seat cushions sit on can accommodate bed base mechanisms for the pull-out bed.





MOOD L 342 H 82 P 170
IN TESSUTO ALFA 42, TAVOLINO
ICARO CON PIANO MARMO CARRARA
GIOIA LUCIDO E STRUTTURA CROMO,
COMPOSIZIONE **SPAZIOTECA**

MOOD W 342 H 82 D 170
IN ALFA 42 FABRIC, **ICARO** COFFEE
TABLE WITH GLOSSY CARRARA
GIOIA MARBLE TOP AND CHROME
STRUCTURE, **SPAZIOTECA**
COMPOSITION



MOOD L 258 H 82 P 96
IN TESSUTO VELVET 11, POUF **EDEN**
L 90 H 40 P 90 IN TESSUTO VELVET 31,
TAVOLINO **ICARO** CON PIANO IN
MARMO CARRARA GIOIA LUCIDO
E STRUTTURA CROMO, POLTRONA
ISOTTA, COMPOSIZIONE **PEOPLE**

MOOD W 258 H 82 D 96
IN VELVET 11 FABRIC, **EDEN** OTTOMAN
W 90 H 40 D 90 IN VELVET 31 FABRIC,
ICARO COFFEE TABLE WITH GLOSSY
CARRARA GIOIA MARBLE TOP AND
CHROME STRUCTURE, **ISOTTA**
ARMCHAIR, **PEOPLE** COMPOSITION



MOOD L 326 H 82 P 304
IN TESSUTO ALFA 52, TAVOLINI
ABACO LACCATO OPACO PERLA,
FUMO E PIOMBO, COMPOSIZIONE
SPAZIOTECA

MOOD W 326 H 82 D 304
IN ALFA 52 FABRIC, PERLA, FUMO
AND PIOMBO MATT LACQUERED
ABACO COFFEE TABLES, **SPAZIOTECA**
COMPOSITION

RIVESTIMENTO TESO
TIGHT FIT

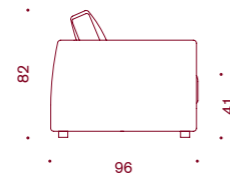
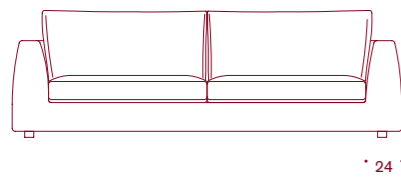
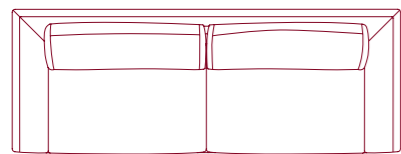

RIVESTIMENTO CON GONNA
COVER WITH SKIRT

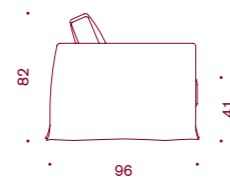
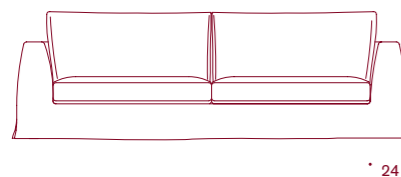
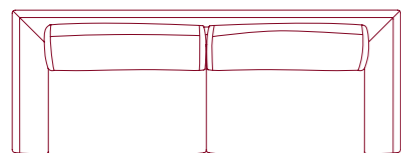

DUO



DUO

Fascino altero, stile sofisticato, design all'avanguardia: Duo è progettato per offrire una soluzione impeccabile alle molteplici esigenze del vivere quotidiano. Studiato tecnologicamente ed esteticamente nei minimi dettagli, il meccanismo di rotazione dello schienale permette di reclinare e sostenere i cuscini, fornendo una doppia profondità di seduta. I braccioli sono larghi e piacevolmente comodi, disegnati per proseguire la linea dello schienale a riposo. Il basamento a slitta, posizionato sotto i braccioli, può essere realizzato con finitura cromata o metallizzata.

Proud appeal, sophisticated style, cutting-edge design: Duo is designed to offer an impeccable solution to the ever-changing demands of daily life. Meticulously designed down to the last technical and aesthetic detail, the backrest's rotating mechanism can be operated to recline the backrest and support the cushions, providing two different seat depths. The armrests are wide and beautifully comfortable, designed to continue the line of the backrest in the reclined position. The skid base, sitting under the armrests, can be produced with a chrome or metallic finish.

DUO L 354-361 H 88 P 354-361
IN TESSUTO PASCA 51 CON
BASAMENTO TITANIO, POUF **EDEN**
L 120 H 40 P 120 IN TESSUTO
VELVET 51, TAVOLINO **ICARO** CON
PIANO VETRO FUME' TRASPARENTE
E STRUTTURA BRONZO

DUO W 354-361 H 88 D 354-361
IN PASCA 51 FABRIC WITH
TITANIUM BASE, **EDEN** OTTOMAN
W 120 H 40 D 120 IN VELVET 51
FABRIC, **ICARO** COFFEE TABLE
WITH TRANSPARENT SMOKEY GREY
GLASS AND BRONZE STRUCTURE



DUO DIVANO IN TESSUTO PASCA 51,
SCHIENALE CON MECCANISMO
RECLINABILE IN POSIZIONE
SOLLEVATA E A RIPOSO

DUO SOFA IN PASCA 51 FABRIC
WITH RECLINABLE BACK

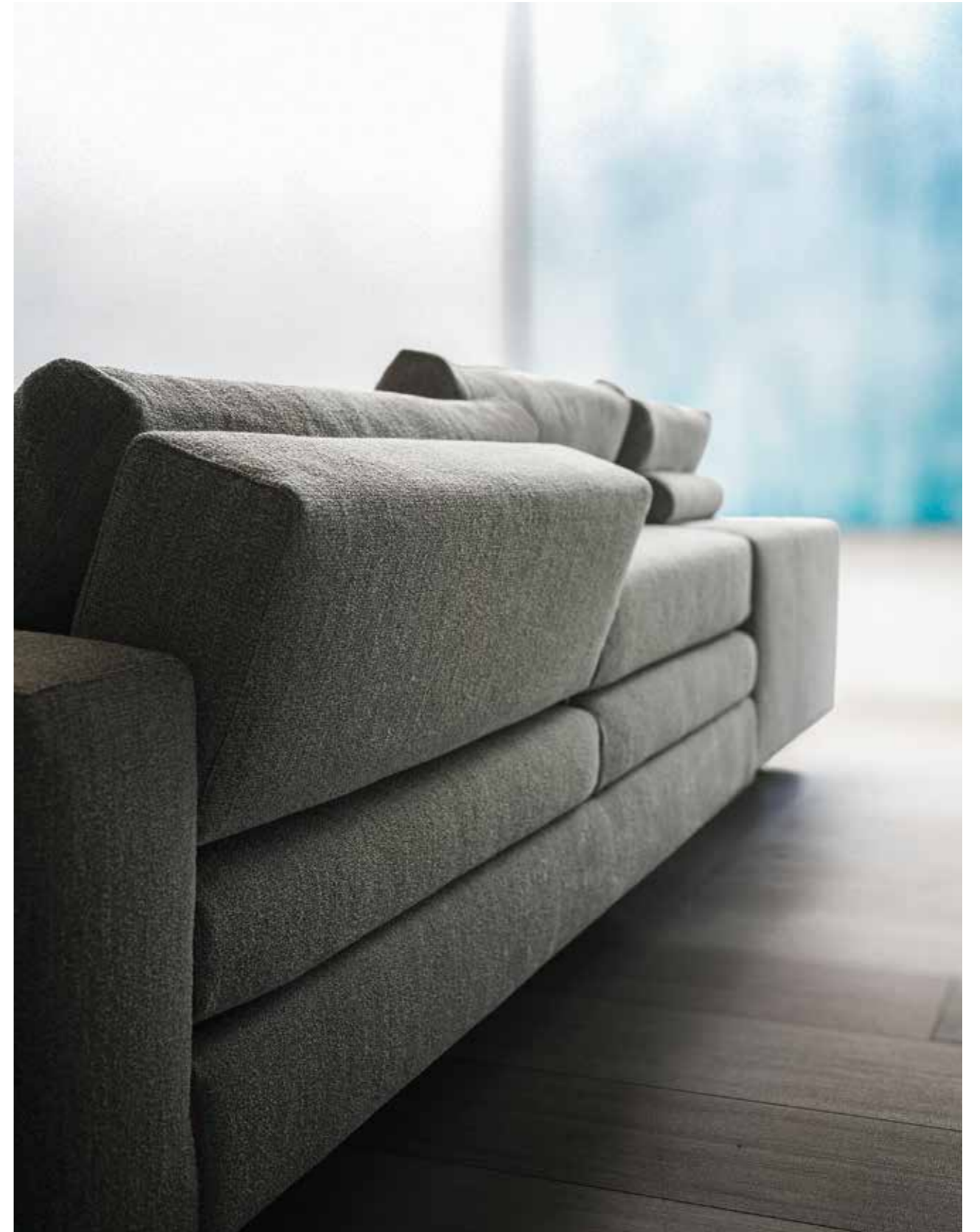





DUO L 354-361 H 88 P 434-441
IN TESSUTO BRERA 11 CON
BASAMENTO BRONZO, TAVOLINI
ABACO LACCATO OPACO NINFEA,
TIMO E CAPPUCCINO, TAVOLINO
1+1 LACCATO OPACO MELANZANA,
SPECCHI **GEOMETRIKA**

DUO W 354-361 H 88 D 434-441
IN BRERA 11 FABRIC WITH
BRONZE BASE, NINFEA, TIMO AND
CAPPUCCINO MATT LACQUERED
ABACO COFFEE TABLES, MELANZANA
MATT LACQUERED 1+1 COFFEE
TABLE, **GEOMETRIKA** MIRRORS

DUO L 274 H 88 P 107-114
IN TESSUTO TAIGAL 51 CON
BASAMENTO TITANIO, TAVOLINI
ABACO LACCATO OPACO
TIMO E FUMO

DUO W 274 H 88 D 107-114
IN TAIGAL 51 FABRIC WITH TITANIUM
BASE, TIMO AND FUMO MATT
LACQUERED **ABACO** COFFEE TABLES



SCHIENALE CON MECCANISMO RECLINABILE
RECLINABLE BACK

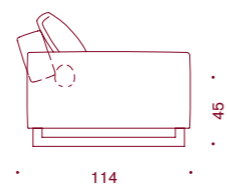
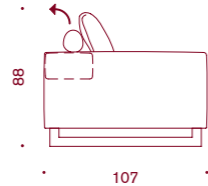
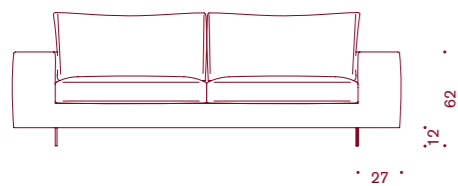
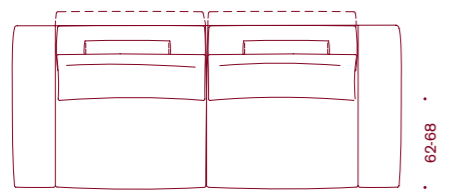

INCONTRO



INCONTRO

Eleganza essenziale, carattere duttile, design lineare: Incontro veste le forme della versatilità, in perfetto equilibrio tra stile classico e moderno. La struttura presenta volumi discreti e piuttosto squadrati, con spessori molto contenuti. Due le versioni proposte: quella più semplice ha una struttura uniforme caratterizzata dagli allineamenti tra i vari elementi, l'altra si distingue per la struttura dello schienale più alta rispetto ai braccioli, per un effetto più dinamico ed informale. I piedini cilindrici, con base leggermente conica, possono essere cromati, metallizzati o laccati nei 20 colori Pianca.

Pared-back elegance, flexible character, linear design: Incontro is versatility in a new guise, striking a perfect balance between classic and modern style. The frame features low-key, rather boxy volumes and an overall slimline design. It comes in two versions: in the simpler version, the various elements of the frame are aligned for a uniform look; while in the other, the distinguishing feature is the backrest frame, which is higher than the armrests, for a more dynamic, casual effect. The cylindrical legs, with a slightly conical base, can be in a chrome or metallic finish or lacquered in any of Pianca's 20 colours.



INCONTRO L 218 H 92 P 93
CON SCHIENALE ALTO IN TESSUTO
LARGEUR 21, POLTRONE
L 84 H 82 P 86 IN TESSUTO RICO 11
E PIEDI LACCATO OPACO ARGILLA,
TAVOLINO **ICARO** CON PIANO
MARMO CARRARA GIOIA LUCIDO E
STRUTTURA CROMO

INCONTRO W 218 H 92 D 93
WITH HIGH BACK IN LARGEUR 21,
ARMCHAIRS W 84 H 82 D 86 IN
RICO 11 FABRIC AND ARGILLA MATT
LACQUERED LEGS, **ICARO** COFFEE
TABLE WITH GLOSSY CARRARA
GIOIA MARBLE TOP AND CHROME
STRUCTURE



INCONTRO L 218 H 82 P 93 E
L 324 H 82 P 93 CON SCHIENALE BASSO
IN TESSUTO RICO 11 E PIEDI LACCATO
OPACO CAPPUCCINO, TAVOLINI **ICARO**
CON PIANO MARMO CARRARA GIOIA
LUCIDO E STRUTTURA BRONZO,
COMPOSIZIONE **SPAZIOTECA**

INCONTRO W 218 H 82 D 93
AND W 324 H 82 D 93 WITH LOW BACK
IN RICO 11 FABRIC AND CAPPUCCINO
MATT LACQUERED LEGS, **ICARO**
COFFEE TABLES WITH GLOSSY
CARRARA GIOIA MARBLE TOP AND
BRONZE STRUCTURE, **SPAZIOTECA**
COMPOSITION

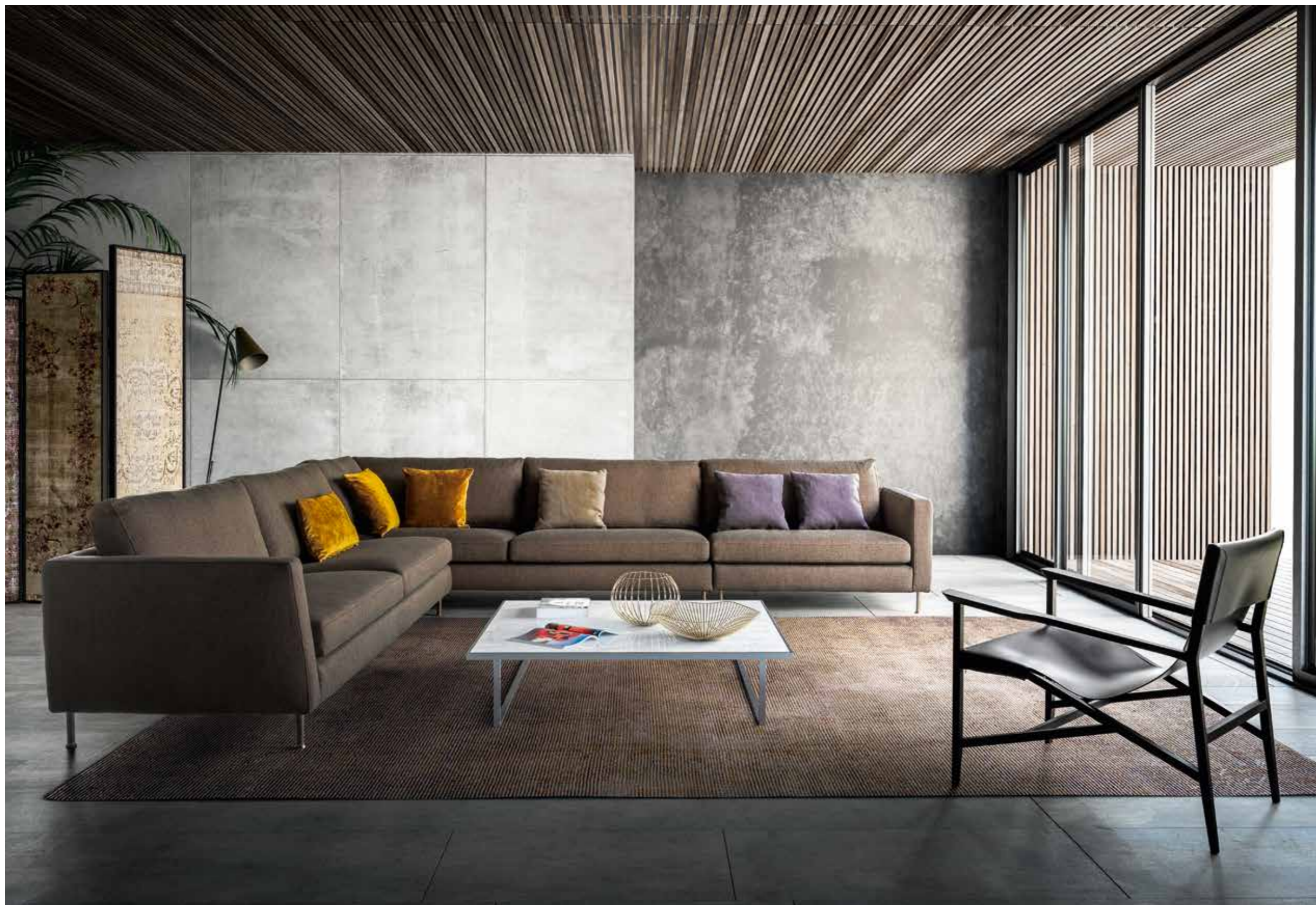

INCONTRO L 368 H 92 P 336
CON SCHIENALE BASSO IN TESSUTO
PERSEO 23 E PIEDI BRONZO,
POLTRONA **ISOTTA** CON SEDUTA
CUOIO NERO E STRUTTURA LACCATO
OPACO NERO, TAVOLINO **ICARO**

INCONTRO W 368 H 92 D 336
WITH LOW BACK IN PERSEO 23
FABRIC AND BRONZE LEGS, **ISOTTA**
ARMCHAIR WITH BLACK BELT
LEATHER SEAT AND BLACK MATT
LACQUERED STRUCTURE, **ICARO**
COFFEE TABLE

INCONTRO L 254 H 92 P 93 CON SCHIENALE ALTO E POUF L 93 H 41 P 93 IN TESSUTO LARGEUR 01 CON PIEDI LACCATO
OPACO BIANCO, TAVOLINO ICARO CON PIANO MARMO CARRARA GIOIA LUCIDO E STRUTTURA CROMO
INCONTRO W 254 H 92 D 93 WITH HIGH BACK AND OTTOMAN W 93 H 41 D 93 IN LARGEUR 01 FABRIC WITH BIANCO MATT
LACQUERED LEGS, ICARO COFFEE TABLE WITH GLOSSY CARRARA GIOIA MARBLE TOP AND CHROME STRUCTURE



SCHIENALE BASSO
LOW BACK

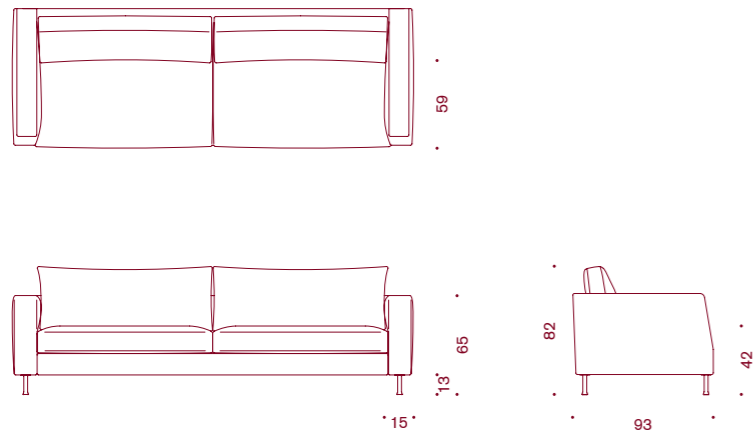

SCHIENALE ALTO
HIGH BACK

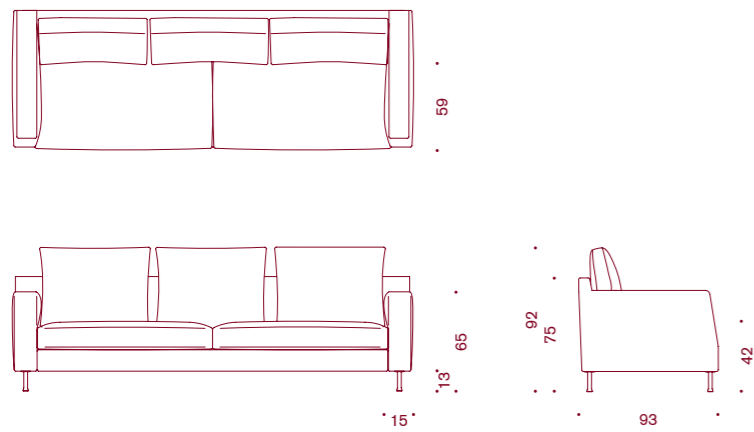

MERIDIANO



MERIDIANO

Carismatico, confortevole e ricercato: grande classico della collezione Pianca. Nasce Meridiano, frutto di un attento lavoro rivolto a perfezionare ogni dettaglio.

Proporzioni, larghi braccioli per aumentare il comfort, poggiatesta cilindrici da integrare allo schienale, doppia opzione per i piedini, in nylon nero a scomparsa oppure massicci e quadrati realizzati in metallo, essenza o laccato, fanno di Meridiano un divano rassicurante e intramontabile.

Dialling up the charisma, comfort and style: a classic bestseller and jewel in Pianca's crown, Meridiano's every detail is honed to perfection. We have tweaked the proportions between the heights of the structure and seat for improved comfort. Luxuriously wide armrests and cylindrical headrests that slot into the back give Meridiano a solid look and comfortable seating. Two feet options: black nylon hidden from view; or square feet made from chrome-plated metal, wood or lacquered.



MERIDIANO L 234 E L 264 H 82 P 107
IN PELLE VINTAGE 32 CON PIEDI
BORGOGNA, TAVOLINI MONO LACCATO
OPACO ZAFFERANO, ARGILLA E CIELO

MERIDIANO W 234 AND W 264 H 82 D 107
IN VINTAGE 32 LEATHER WITH
BURNT OAK LEGS, ZAFFERANO,
ARGILLA AND CIELO MATT
LACQUERED MONO SIDE TABLES



MERIDIANO L 459 H 82 P 180
E POUF L 107 H 43 P 107 IN
TESSUTO LIMA 21, POLTRONE
DOLCEVITA IN TESSUTO SWEET 32,
COMPOSIZIONE SPAZIOTECA

MERIDIANO W 459 H 82 D 180
AND OTTOMAN W 107 H 43 D 107
IN LIMA 21 FABRIC, DOLCEVITA
ARMCHAIRS IN SWEET 32 FABRIC,
SPAZIOTECA COMPOSITION





MERIDIANO L 364 H 82 P 344 IN TESSUTO THALIS UNITO 51 CON PIEDI CROMO, TAVOLINI ABACO LACCATO OPACO NINFEA E ARGILLA
MERIDIANO W 364 H 82 D 344 IN THALIS UNITO 51 FABRIC WITH CHROME LEGS, NINFEA AND ARGILLA MATT LACQUERED ABACO COFFEE TABLES

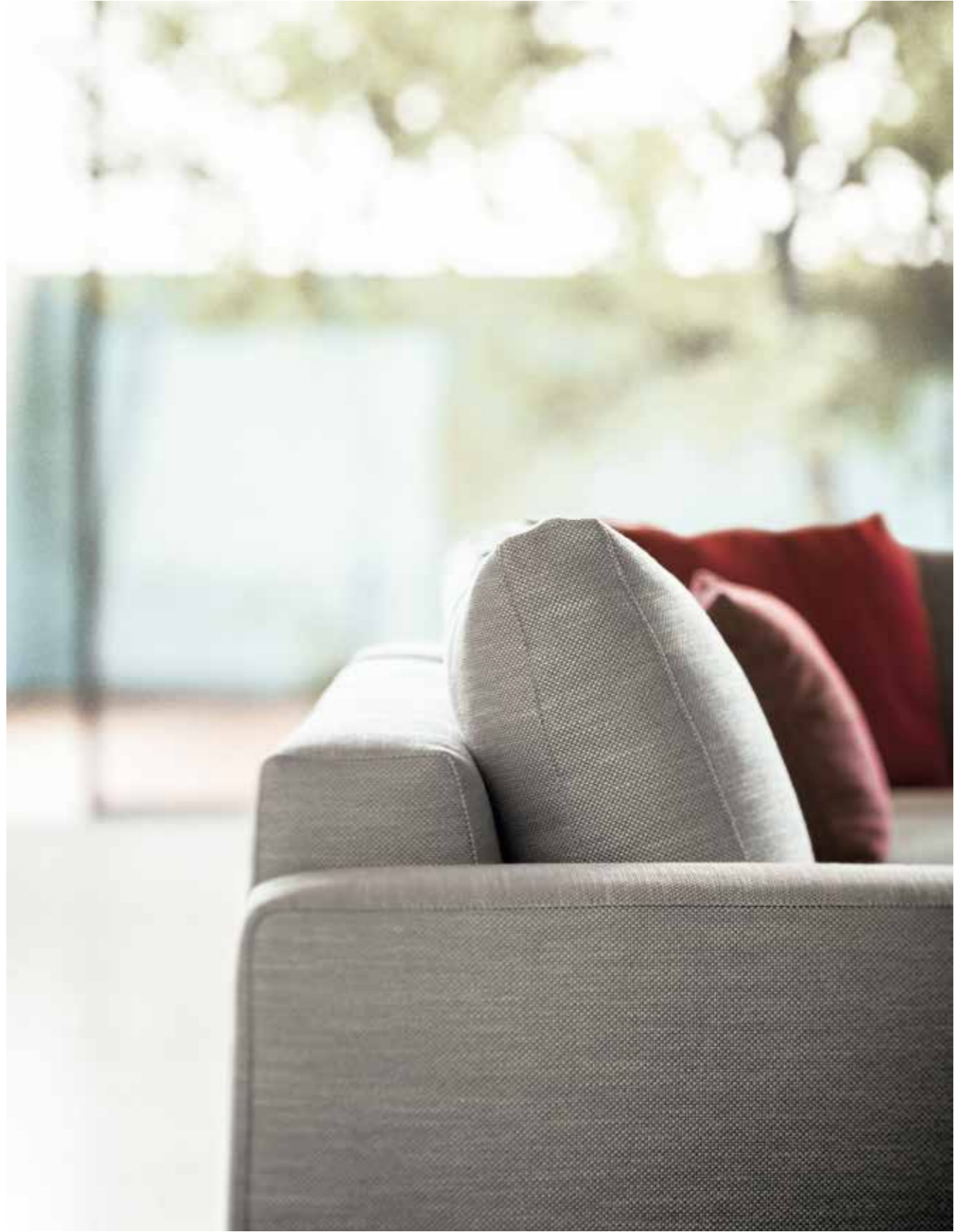
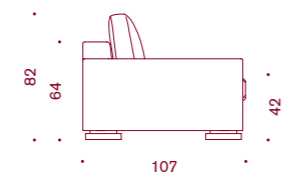
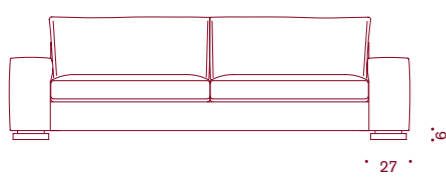
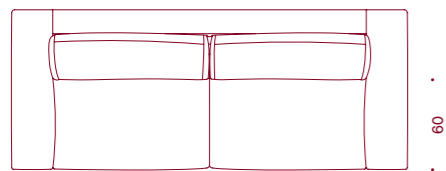

OTTO



OTTO

Design by Aldo Cibic

Accogliente ed avvolgente, rassicurante nelle sue linee classiche, che ricordano i divani di famiglia di un tempo, Otto è un divano la cui bellezza risiede nella semplicità. La struttura è caratterizzata dal profilo curvilineo dello schienale, che rende la seduta spaziosa ed invitante, con una profondità che raggiunge i 120 cm. Il cuscino di seduta è fatto quasi interamente in piuma, per donare morbidezza e comfort, garantito anche dall'abbondanza di cuscini appoggiati allo schienale. La fodera riveste morbidamente tutta la struttura.

Cosy and enveloping, reassuring in its classic lines that remind us of the family sofas of old, Otto is a sofa whose beauty lies in its simplicity. The frame's distinguishing feature is the curvilinear profile of the backrest, which makes the seat spacious and inviting, its depth expanding to a good 120 cm. The seat cushion is almost entirely down filled to give softness and comfort, which is also provided by the plentiful 45x45cm scatter cushions sitting against the backrest. The loose cover drapes softly over the whole frame.

OTTO L 240 H 64 P 120
IN TESSUTO BRENDA 01, TAVOLINI
ABACO LACCATO OPACO NUVOLA
E FUMO, COMPOSIZIONE UNLESS

OTTO W 240 H 64 D 120
IN BRENDA 01 FABRIC, NUVOLA
AND FUMO MATT LACQUERED ABACO
COFFEE TABLES, UNLESS BOOKCASE



OTTO L 240 H 64 P 120 IN TESSUTO SWEET 41, TAVOLINI ABACO, SERVOGIRO E ICARO, COMPOSIZIONE SPAZIO
OTTO W 240 H 64 W 120 IN SWEET 41 FABRIC, ABACO, SERVOGIRO AND ICARO COFFEE TABLES, SPAZIO COMPOSITION



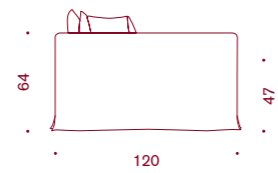
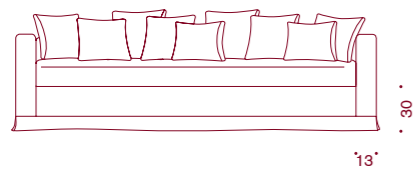
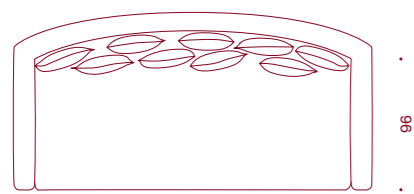

POLTRONE ARMCHAIRS



DORA

Design by Metrica

Design moderno e versatile, geometrie avvolgenti, dettagli sofisticati: Dora è una poltrona leggera, pratica e molto versatile. Generosa nelle dimensioni, confortevole nelle forme e nelle imbottiture, la scocca rappresenta il suo elemento caratteristico: un'unica superficie che si curva e modella intorno alle forme del corpo. Alto ed accogliente, lo schienale offre il massimo sostegno a testa e spalle. Il rivestimento può essere in tessuto sfoderabile o in pelle non sfoderabile. Esile e slanciata, la struttura del basamento è disponibile in acciaio inox satinato, alluminio brunito satinato o verniciato, nei colori bianco e lavagna.

Modern and versatile design, wraparound geometries, sophisticated details: Dora is a light, practical and highly versatile armchair. Generous in size, comfortable in shape and padding, the carcass is definitely its distinguishing feature: a single surface that bends and moulds to the shape of the body. High and welcoming, the backrest offers supreme support for the head and shoulders. It comes with removable fabric covers or non-removable leather upholstery. Slimline and slender, the base frame is available in brushed stainless steel, aluminium with a satin bronze finish or can be in bianco or lavagna lacquered.



DORA L 76 H 113 P 82
E POUF L 55 H 42 P 50 IN TESSUTO
RICO 44 CON BASAMENTO
VERNICIATO LAVAGNA

DORA W 76 H 113 D 82
AND OTTOMANS L 55 H 42 P 50
IN RICO 44 FABRIC WITH
LAVAGNA LACQUERED BASEMENT



DORA L 76 H 113 P 82
IN TESSUTO TAIGAL 41 E PELLE
SINTETICA EXTREMA 44, BASAMENTO
VERNICIATO LAVAGNA E BIANCO,
TAVOLINO **HAIK** ARGENTO, TAVOLINI
ICARO CON PIANO MARMO
EMPERADOR LUCIDO E STRUTTURA
BRONZO, COMPOSIZIONE **SPAZIO**

DORA W 76 H 113 D 82
IN TAIGAL 41 FABRIC AND EXTREMA
44 SYNTHETIC LEATHER, BIANCO AND
LAVAGNA LACQUERED BASE, SILVER
HAIK COFFEE TABLE, **ICARO** COFFEE
TABLES WITH GLOSSY EMPERADOR
MARBLE TOP AND BRONZE
STRUCTURE, **SPAZIO** COMPOSITION



DIALOGO

Accogliente, morbida, abbondante: Dialogo è un invito al relax. Come un nido sicuro, al riparo dal frenetico scorrere dei ritmi quotidiani, offre una seduta spaziosa e confortevole, perfetta per concedersi una pausa. Due le versioni disponibili, pensate per offrire proposte estetiche e tattili molto diverse: la versione con rivestimento in tessuto sfoderabile e confezione tesa, la versione in pelle non sfoderabile, che segue la struttura più morbidamente e presenta dettagli di cucitura perimetrale più evidenti e connotanti.

Soft and inviting, Dialogo begs you to sink into its ample embrace. Like a safe nest, shielding you from the hectic pace of daily life, it offers a spacious, comfortable seat, perfect for taking a timeout. It comes in two versions, designed to offer two very different aesthetic and tactile options: a version with removable fabric covers fitting snugly over the frame; and a version with non-removable leather upholstery that has a more relaxed fit and features more evident, connotative seams around the outer edges.



DIALOGO L 84 H 88 P 98
E POUF L 68 H 44 P 56 IN
TESSUTO PERSEO 23, TAVOLINI
ABACO LACCATO OPACO LAVAGNA

DIALOGO W 84 H 88 D 98
AND OTTOMAN W 68 H 44 D 56 IN
PERSEO 23 FABRIC, LAVAGNA MATT
LACQUERED ABACO COFFEE TABLES

DIALOGO L 84 H 88 P 98
IN PELLE LORD 88, TAVOLINO
ICARO, COMPOSIZIONE SPAZIOTECA

DIALOGO W 84 H 88 D 98
IN LORD 88 LEATHER, ICARO
COFFEE TABLE, SPAZIOTECA
COMPOSITION

RIVESTIMENTO POLTRONA
DIALOGO IN TESSUTO O PELLE

DIALOGO ARMCHAIRS COVER IN
FABRIC OR LEATHER





OPLA'

Eclettica ed elegante, Oplà veste le forme di un romantico e caldo abbraccio. Un moderno pozzetto dalle linee completamente arrotondate, con volumi e proporzioni importanti, che offrono un confortevole ed avvolgente sostegno. La seduta è costituita da un alto e morbido cuscino disegnato per scivolare perfettamente nell'invaso centrale della scocca. Simili a venature di un fiore, le cuciture interne allo schienale ne esaltano l'armoniosa geometria. Disponibile sia la versione in tessuto sfoderabile che quella in pelle non sfoderabile. Il basamento può essere fisso o girevole, dotato di meccanismo di ritorno.

Eclectic and elegant, Oplà is the armchair equivalent of a warm, romantic embrace. A modern tub chair designed with rounded lines from head to toe and featuring prominent volumes and proportions offering comfortable, wraparound support. The seat consists in a high, soft cushion designed to slot perfectly into the hollow in the middle of the carcass. Resembling the veins of a flower, the stitching on the inside of the backrest plays up the harmonious geometry. Available the version with removable fabric covers and the non-removable leather upholstery version. The base can be fixed or comes in a swivel version with auto-return mechanism.



OPLA' L 70 H 80 P 70
CON BASAMENTO GIREVOLE
IN TESSUTO VELVET 31

OPLA' W 70 H 80 D 70
WITH SWIVELING BASEMENT
IN VELVET 31 FABRIC



PAESAGGIO

Design by Giampaolo Babetto

Essenziale e discreta, Paesaggio è una panca adatta ad inserirsi in qualsiasi ambiente. Il suo profilo alterna linee più morbide a tratti più spigolosi, ispirato concettualmente all'idea di un paesaggio semplice, che all'orizzonte mostra un andamento dolcemente naturale. Il cuscino cilindrico crea un'interruzione visiva e un piccolo elemento d'appoggio. Il basamento in acciaio spazzolato, dallo stile sobrio e minimale, connette i tre elementi dell'insieme. E' disponibile in due misure differenti.

Pared back and discreet, Paesaggio is a bench that sits well in any interior. Its profile alternates soft lines with sharper features, inspired conceptually by the idea of a simple landscape whose naturally gentle rolling forms stand out on the horizon. The cylindrical cushion visually breaks up the run of seating and serves as a small rest. The brushed steel base, with its restrained minimal style, joins the three elements together. It comes in two different sizes.

PAESAGGIO L 240 H 48 P 45
CON SEDUTA E RULLO IN PELLE
SINTETICA EXTREMA 42 E 49,
BASE IN METALLO SPAZZOLATO

PAESAGGIO BENCH
W 240 H 48 D 45, SEAT AND ROLL
CUSHION IN EXTREMA 42 AND
EXTREMA 49 SYNTHETIC LEATHER,
BRUSHED METAL BASE





PAESAGGIO PANCA L 240 H 48 P 45
CON SEDUTA E RULLO IN PELLE
SINTETICA EXTREMA 49, BASE IN
METALLO SPAZZOLATO

PAESAGGIO BENCH
W 240 H 48 D 45, SEAT AND ROLL
CUSHION IN EXTREMA 49 SYNTHETIC
LEATHER, BRUSHED METAL BASE



ISOTTA

Linee chiare, leggibili, contemporanee: Isotta riduce all'essenziale la seduta, rinunciando a volumi e a imbottiture, ma non al comfort. Una fascia di morbido cuoio, disponibile in bianco o in nero, si modella individualmente sulle forme e sulla postura del corpo, agganciandosi alla struttura solo alle due estremità finali. La base è interamente in legno, disponibile in frassino naturale o laccato opaco bianco o nero. Le gambe sagomate sono connesse tra loro da un gioco di lineari geometrie, progettate per risolvere con stile la statica della seduta.

Clear, legible, contemporary lines: Isotta pares seating back to the bare essentials, doing away with volume and padding, but not comfort. A strip of belt leather, available in white or black, moulds individually to the shape and posture of the body, attaching to the frame just at the two ends. The base is made entirely from wood, available in natural ash, white or black matt lacquered finish. The shaped legs are connected together in a linear geometric pattern, a stylish solution designed to keep the chair stable.



ISOTTA L 75 H 82 P 80
 IN CUIO NERO CON STRUTTURA
 LACCATO OPACO NERO, TAVOLINO
ABACO LACCATO OPACO LAVAGNA

ISOTTA W 75 H 82 D 80
 IN BLACK BELT WITH NERO MATT
 LACQUERED STRUCTURE, LAVAGNA
 MATT LACQUERED **ABACO** COFFEE TABLE



DOLCEVITA

Armoniosa fusione di caratteri diversi, equilibrato incontro di forme dolci e squadrate, Dolcevita è una poltrona dal design ricercato e riconoscibile. In lei convivono un'anima più formale e una più informale, che emergono in base al contesto e al rivestimento scelto. La struttura ha una presenza importante e voluminosa, di forma pressoché quadrata in pianta, rialzata da terra da un basamento girevole in acciaio cromato. La seduta è morbida e confortevole, grazie al cuscino alto e profondo e ai volumi internamente arrotondati dei braccioli e dello schienale.

Harmonious merging of different characters, a balanced marriage of soft and square shapes, Dolcevita is an armchair sporting a stylish, stand-out design. A happy juxtaposition of the formal and the more casual, its setting and the upholstery chosen determining which quality emerges. The frame has a conspicuous, voluminous presence, featuring an almost square "footprint", though the chair is raised off the floor by a chrome-plated steel swivel base. With its high, deep cushion and the rounded inside surfaces of the armrests and backrest, it makes a soft and comfortable seat.

DOLCEVITA L 74 H 62 P 76
IN TESSUTO SWEET 34 CON
BASAMENTO GIREVOLE CROMO,
TAVOLINO **ABACO** LACCATO
OPACO MELANZANA

DOLCEVITA W 74 H 62 D 76 IN
SWEET 34 FABRIC WITH CHROME
SWIVELING BASE, MELANZANA MATT
LACQUERED **ABACO** COFFEE TABLE





POUF

Pianca offre una vasta gamma di pouf, diversi per dimensioni, materiali, colori e forme: quadrati, rettangolari, tondi, trapezoidali. Si adattano ad ogni situazione o esigenza, dalla più classica alla più moderna, dalla più spaziosa alla più contenuta. In base al materiale scelto per il rivestimento e in funzione del modello, la fodera è fissa o sfoderabile. Per alcuni modelli è realizzabile anche la versione capitonné, finemente trapuntata.

Pianca offers an extensive range of ottomans, differing in size, material, colour and shape: square, rectangular, round and trapezoidal. Catering to all manner of requirements, they sit happily any setting, from a classic to a more modern interior, from the largest of rooms to the tightest of spaces. Depending on the material chosen for the upholstery and depending on the model, the cover may be fixed or removable. Some models can also be produced in a finely tufted version.

EDEN CAPITONNE' Ø 120 H 40
IN TESSUTO SWEET 44 E
DIALOGO L 68 H 44 P 56 IN
TESSUTO PERSEO 23

EDEN CAPITONNE' Ø 120 H 40
IN SWEET 44 FABRIC AND
DIALOGO W 68 H 44 D 56 IN
PERSEO 23 FABRIC





TESSUTI E PELLI FABRIC AND LEATHER

Vastissima e variegata è la gamma di rivestimenti: una selezione di tessuti, pelli e pelli sintetiche che compongono un mosaico di circa 240 possibilità. Oltre ai più classici tessuti dalle composizioni naturali, quali lane, cotone e lino, sono disponibili morbidi velluti e tessuti tecnici, come quelli ignifughi ed idrorepellenti. Molteplici i colori e le texture: intrecci semplici o trame più complesse. Cinque le tipologie di pelli naturali: dalla grana liscia fino ad arrivare alla pelle a pieno fiore all'anilina, morbida e setosa, con piccole rughe e difetti naturali, che rappresentano il valore intrinseco della materia, il suo pregio e la sua unicità.

The wide and varied range of coverings includes a selection of fabrics, leather and imitation leather forming a medley of around 240 options. In addition to classic fabrics made from natural fibres, such as wools, cottons and linens, we also have soft velvets and technical fabrics, such as the fire-retardant and water-repellent options. There is a vast array of colours and textures: from simple woven fabrics to more complex weaves. There are five types of natural leather to choose from: ranging from smooth grain to the soft and silky aniline full-grain leather, whose little wrinkles and natural defects are an inherent feature of quality leather and are what makes the material so unique.

BIANCO

CAT.A



ALFA 01

ALFA 04

FUNNY 01

PENNY 01

PENNY 02

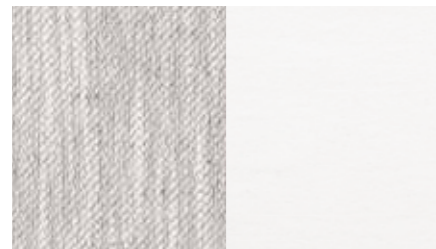

PENNY 03

WOW 01

CAT.B



BRERA 01

BYTE 01

KOS 01

MICRON 01

MICRON 02

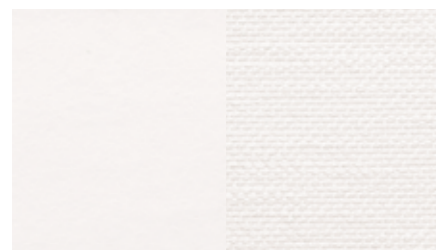

SWEET 01

THALIS UNITO 01

CAT.C



BRENDA 01

MORITZ 01

PASCA 01

PASCA 02

RICO 01

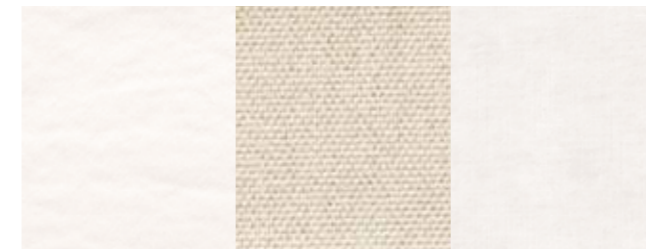

SHABBY UNITO 02

TAIGAL 01

VELVET 01

CAT.H

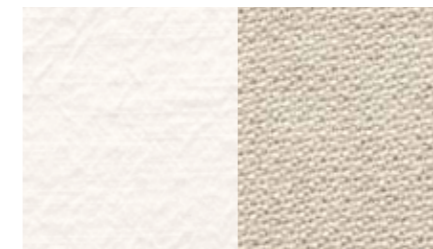

LARGEUR 01

PERSEO 01

BEIGE

CAT.A



FUNNY 12

GAUCHO 11

GAUCHO 12

LIMA 11

PENNY 11

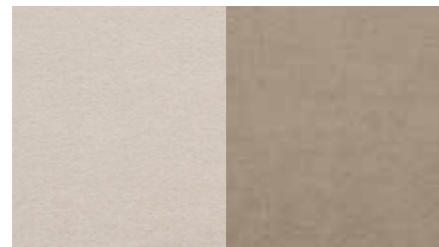

WOW 11

WOW 12

CAT.B



AMALFI 11

BRERA 11

BYTE 12

KOS 11

MICRON 11



POSITANO 11

SWEET 11

THALIS UNITO 11

CAT.C

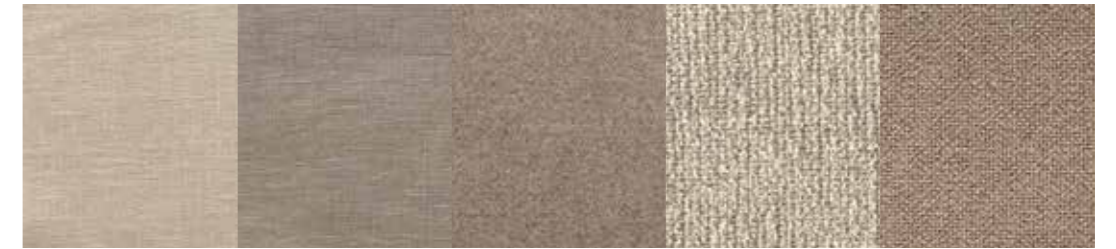

BRENDA 12

BRENDA 13

MORITZ 11

PASCA 11

RICO 11



SHABBY UNITO 11

SHABBY UNITO 12

SHABBY UNITO 13

TAIGAL 11

VELVET 11

VELVET 12

CAT.H



LARGEUR 11

MARRONE E ARANCIONE

CAT.A

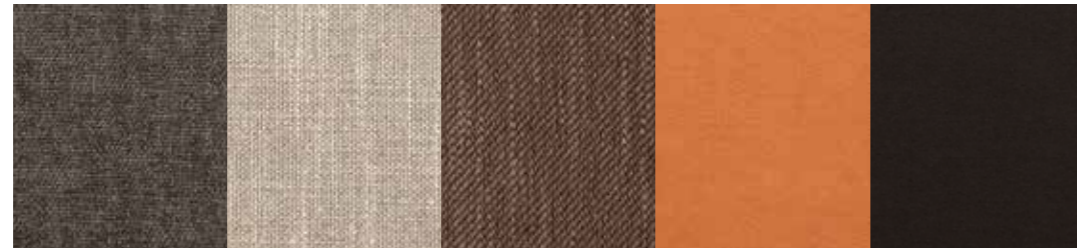

GAUCHO 21

LIMA 21

PENNY 21

WOW 21

WOW 22

CAT.B



BRERA 21

BYTE 21

MICRON 21

SWEET 22

SWEET 23

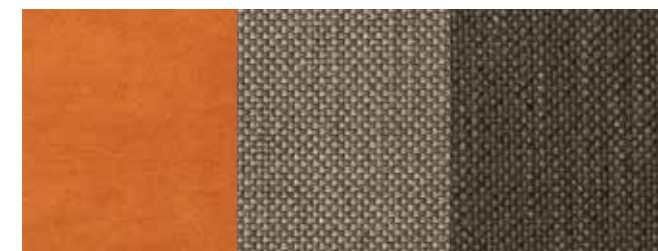

SWEET 34

THALIS UNITO 21

THALIS UNITO 22

CAT.C



BRENDA 21

BRENDA 23

PASCA 21

RICO 21

RICO 22



SHABBY UNITO 21

TAIGAL 21

TAIGAL 22

TAIGAL 23

CAT.H



LARGEUR 21

PERSEO 21

PERSEO 22

PERSEO 23

ROSSO E VIOLA

CAT.A



ALFA 32

WOW 31

WOW 33

CAT.C



BRENDA 31

RICO 33

SHABBY UNITO 31

VELVET 31

VELVET 32

CAT.B



AMALFI 31

POSITANO 31

SWEET 32

SWEET 33



VELVET 33

CAT.C



MORITZ 31

MORITZ 32

PASCA 31

RICO 31

RICO 32

CAT.H



PERSEO 31

BLU

CAT.A



ALFA 45 FUNNY 43 FUNNY 44 GAUCHO 41 PENNY 41

CAT.C



BRENDA 41 PASCA 41 RICO 41 RICO 42 RICO 43

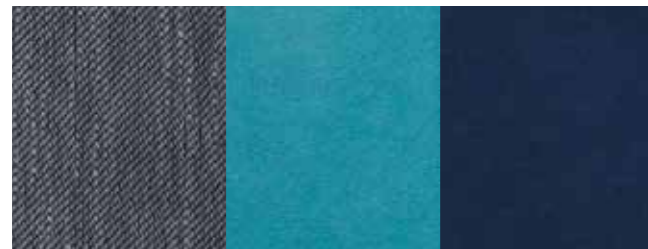

PENNY 42 WOW 41 WOW 42



TAIGAL 41 TAIGAL 42 VELVET 41 VELVET 42

CAT.B



AMALFI 41 BYTE 41 POSITANO 41 SWEET 44

CAT.H



LARGEUR 41 PERSEO 41

GIALLO E VERDE

CAT.A



ALFA 42

BRERA 41

WOW 43

CAT.B



AMALFI 42

POSITANO 42

SWEET 41

SWEET 42

SWEET 43

CAT.C



MORITZ 41

MORITZ 42

PASCA 42

RICO 44

RICO 45

CAT.C

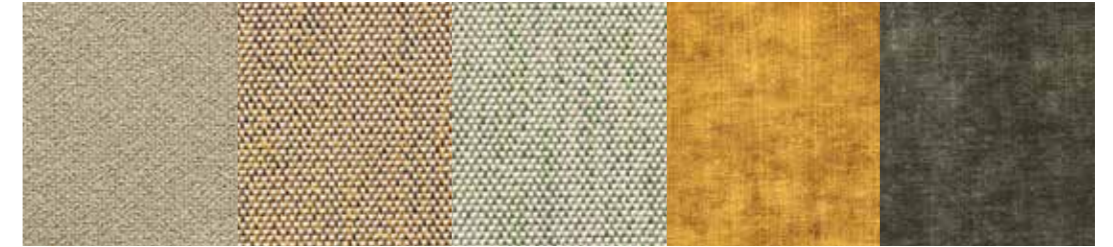

RICO 46

TAIGAL 43

TAIGAL 44

VELVET 43

VELVET 44

CAT.H



LARGEUR 42

GRIGIO E NERO

CAT.A



ALFA 52

FUNNY 51

FUNNY 52

FUNNY 54

GAUCHO 51



LIMA 51

CAT.B



AMALFI 51

BRERA 51

KOS 51

KOS 52

KOS 53

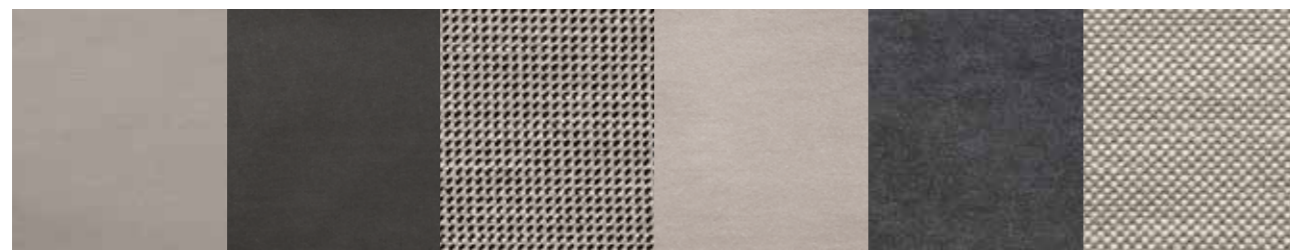

MICRON 51

MICRON 52

POSITANO 51

SWEET 12

SWEET 51

THALIS UNITO 51

CAT.C

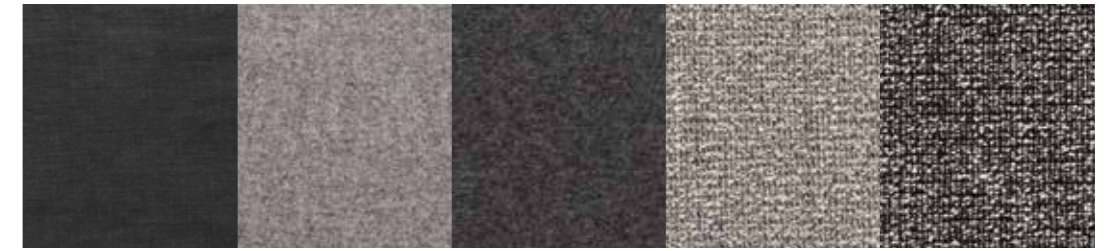

BRENDA 51

MORITZ 51

MORITZ 52

PASCA 51

PASCA 52



RICO 51

SHABBY UNITO 51

TAIGAL 51

VELVET 51

VELVET 53

CAT.H



LARGEUR 51

PELLI

CAT.H



POLO 10 POLO 11 POLO 12 POLO 13 POLO 14



VINTAGE 31 VINTAGE 32 VINTAGE 33 VINTAGE 35

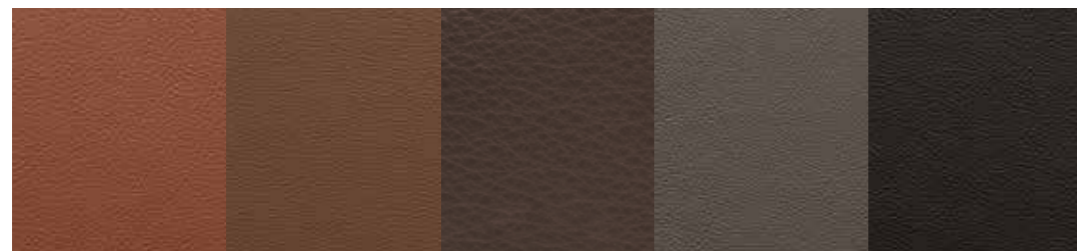

POLO 15 POLO 16 POLO 17 POLO 18 POLO 19

CAT.Q

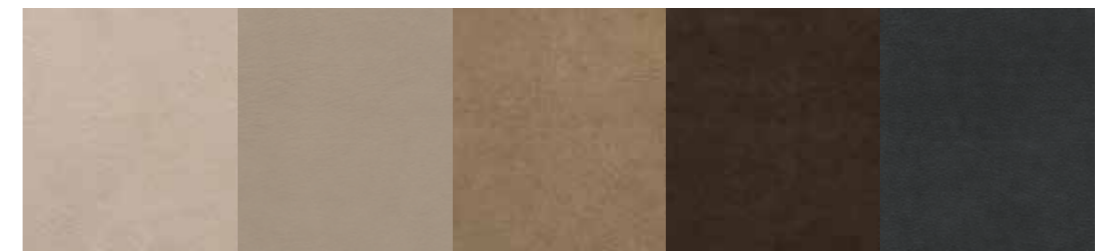

NABUK 40 NABUK 41 NABUK 42 NABUK 43 NABUK 44

CAT.P



LORD 80 LORD 81 LORD 82 LORD 83 LORD 84



SOFTY 60 SOFTY 61 SOFTY 62 SOFTY 63 SOFTY 64 SOFTY 65



LORD 85 LORD 86 LORD 87 LORD 88 LORD 89

SPECIALI

CAT.A



BLOOM 01 BLOOM 06 BLOOM 07 BLOOM 08 BLOOM 09



BLOOM 12 BLOOM 13 BLOOM 14 BLOOM 15 BLOOM 16 BLOOM 17



BLOOM 18 BLOOM 19 TRANZERELLE 60 TRANZERELLE 61 TRANZERELLE 62 TRANZERELLE 63

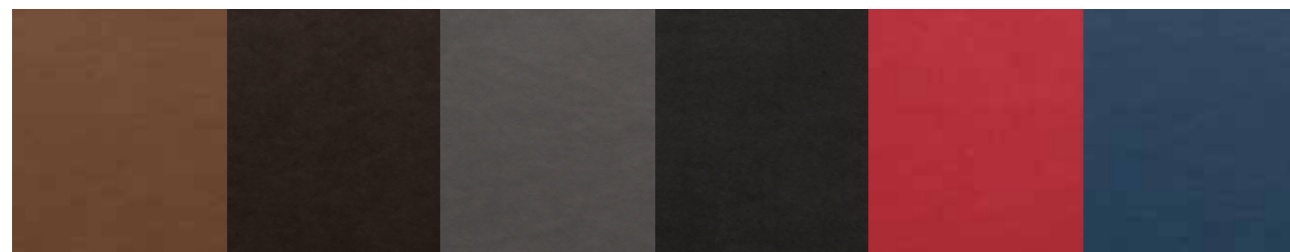

TRANZERELLE 64 TRANZERELLE 65 TRANZERELLE 66 TRANZERELLE 67 TRANZERELLE 68 TRANZERELLE 69



TRANZERELLE 70 TRANZERELLE 71 TRANZERELLE 72

CAT.B

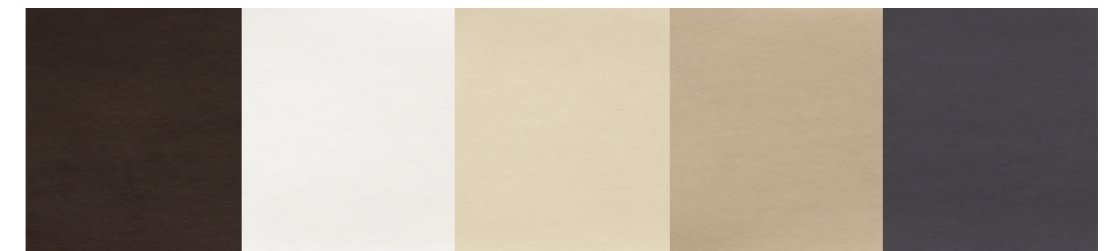

EXTREMA 41 EXTREMA 42 EXTREMA 43 EXTREMA 44 EXTREMA 46



EXTREMA 47 EXTREMA 48 EXTREMA 49 EXTREMA 50 EXTREMA 51 EXTREMA 52



EXTREMA 53 EXTREMA 54

ART DIRECTION
MARCO VIOLA STUDIO

VIRTUAL PHOTOGRAPHY
NUDESIGN

FOTOGRAPHY
IKONPHOTO

STYLING
MARCO VIOLA

PRINT
SINCROMIA
COD. 161610

PIANCA SPA

Via dei Cappellari, 20 - 31018 Gaiarine (TV)
PH. +39.0434.756911 - FAX +39.0434.75330
info@pianca.com - www.pianca.com

CAP. SOC. EURO 5.000.000 I.V.
C. FISC. 00983830308 - P. IVA IT01682580269
R. IMPR. TV00983830308
R.E.A. TV N. 145785 - EXPORT M/TV 025635
C. ID. IT01682580269