

# The 2023 Pleasures Collection

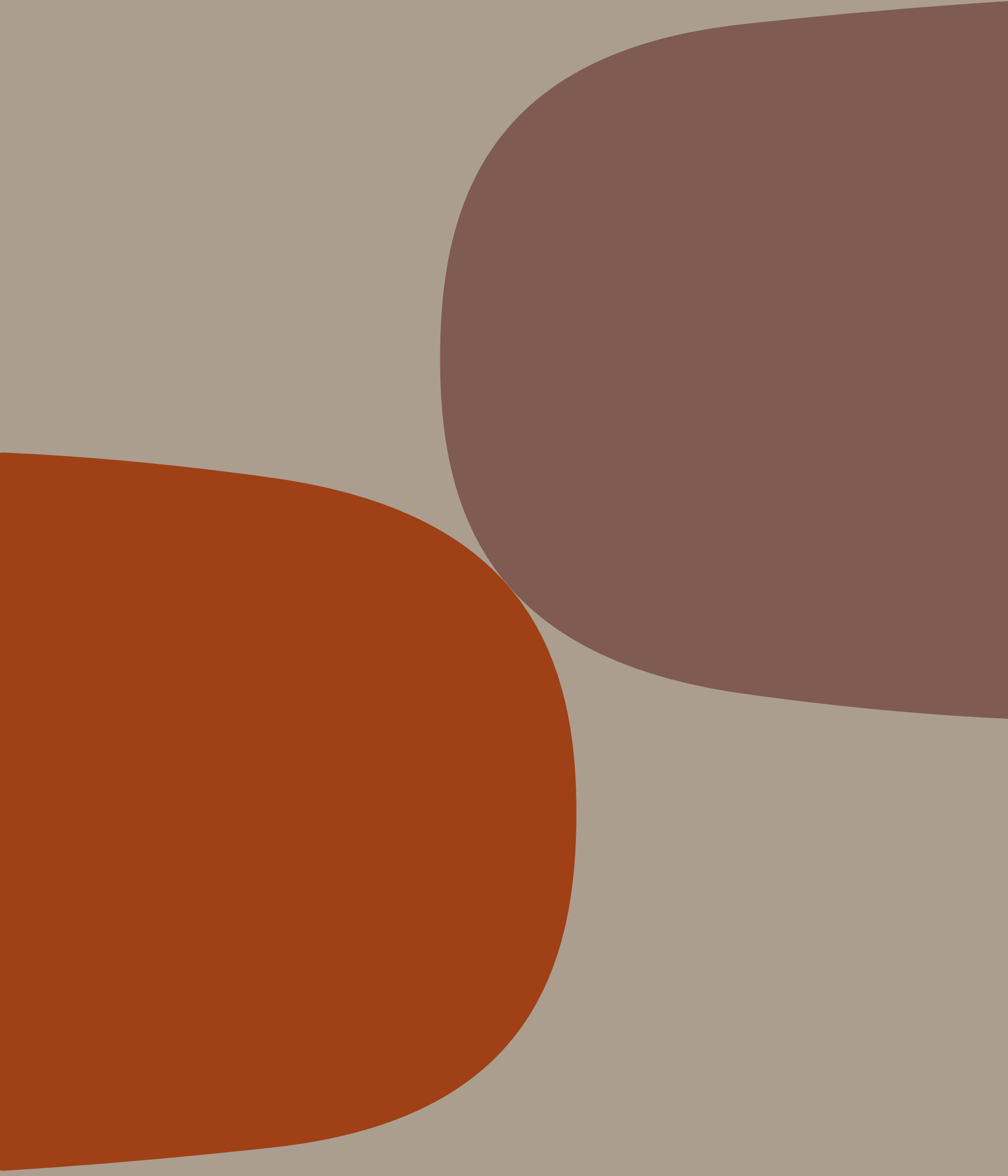







The 2023  
Pleasures Collection  
**Main Index**

06	Pleasure of Comfortable Living	128	Pleasure of Writing Pineider x Poltrona Frau
66	Archibald	130	A4 Notepad holder
98	Bob & Bob with drawer	134	Notebook
76	Downtown Conference	136	Rollerball pen
114	Fascination		
94	Fidelio Low Cabinet	145	Translations and Technical Drawings
102	Ikiperu Ceramics		
108	Ikiperu Patchwork Cushions		
86	Infinitamente		
112	Le Lampade		
80	Montera Mas		
120	Trusty		
124	Weavers Home Fragrance		

# Pleasure of Comfortable Living

## Armchairs, Sofas



66 Archibald

## Chairs, Small Armchairs, Stools



76 Downtown Conference



80 Montera Mas

## Tables, Small Tables



98 Bob &  
Bob with drawer



86 Infinitamente  
Limited Edition

## Bookcases, Storage Units



94 Fidelio Low Cabinet

## Complementary Units, Accessories



114 Fascination



102 Ikiperu Ceramics



108 Ikiperu Patchwork Cushions



112 Le Lampade



120 Trusty



124 Weavers Home Fragrance

## Pleasure of Writing Pineider x Poltrona Frau

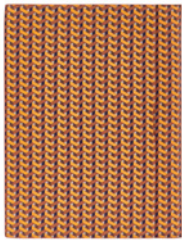

130 A4 Notepad holder



134 Notebook



136 Rollerball pen

# Pleasure of Comfortable Living

Poltrona Frau's 2023 Pleasures Collection traces a new creative path in the name of pleasure: the pleasure of being surrounded by objects that tell stories, carry emotions, and elevate the contemporary living experience. New releases as well as line extensions, all marked by an unmistakable minimalist and refined style, contribute to shaping new ways of living in which the human experience takes center stage. The pleasure of inhabiting spaces and tailoring them to suit one's own aesthetic vocations finds expression in a series of furnishings and accessories with Poltrona Frau's unmistakable minimalist and timeless elegance.

The Infinitamente sculptural table represents the ongoing artistic research on marble begun by Roberto Lazzeroni with last year's highly successful "Infinito" table. Offered in a limited edition, the Infinitamente table is made entirely of marble (Bianco Levigiani for the top, Nero Marquina for the base), and showcases complex and careful workmanship. Infinitamente is available in two sizes, a more compact one with an oval top and single base, or a larger one with a staggered double oval top and double base. The inherent properties of marble mean that each piece has a unique visual appearance in terms of brightness, veins, and shades.

Poltrona Frau reworks some of its icons in the pursuit of comfort and functionality, offering range expansions and restyles. The Montera and Montera Mas seats, designed by Roberto Lazzeroni, are enriched with new versions: a stool with metal legs for Montera; and new stools with metal or wooden legs or a column base for the latest version of Montera Mas. The upholstered seat can be either in leather or removable fabric.

Jean-Marie Massaud's Downtown Conference home-office chair is refreshed with a new five-spoke base with wheels.

Archibald, the iconic armchair designed by Jean-Marie Massaud that has entered the collective memory thanks to its signature wavy upholstery and folded armrests, features a range extension with a new two-seater sofa, a new removable fabric cover, and new titanium painted finish for the base and legs.

The Bob collection of coffee tables designed by Jean-Marie Massaud is extended with two new models and a new finish: a new version with square top, available in various sizes; with integrated drawer, ideal as a bedside table; with top in Marquina Black Marble.

The Fidelio storage cabinet by Roberto Lazzeroni, a roomy storage system with a prominent graphic style, launches in a new compact edition with a length of 180 cm. Unchanged remain the minimalist design and sophisticated finishes, resulting in a versatile collection that can be easily matched with all other Poltrona Frau pieces of furniture.

Poltrona Frau's lighting collections Holly, Fede, and Dido by Jean-Marie Massaud are broadened with new shapes and lampshade hues. The lamps, which feature an elegant blown glass workmanship, are now even more contemporary thanks to new fabric lampshades in elegant pearl, stone, and dark blue/gray tints.

Poltrona Frau's ability to create scenic environments with timeless appeal also shows in four new accessory collections.

Norwegian designer Kristine Five Malvaer brings pop and contemporary twists in the new Ikiperu collection, named after the ancient Etruscan divinity of water and fertility Cupra, an archetype of feminine shapes and abundance. The collection consists of a vase, a bowl, and a small pot with lid, all made in Umbrian ceramic with a pronounced graphic appearance. Visual and tactile contrasts are created by the different color bands and textures of the glazed and unglazed areas. Ikiperu also features a series of cushions that echoes the geometric shapes of the ceramics and enhances the Pelle Frau Velvety upholstery with a double color patchwork.

The art of leather crafting is also the focus of the new collections Fascination, Trusty, and Weavers Home Fragrances.

Fascination, created by Poltrona Frau Style & Design Centre, is the set of leather-covered jewelry and watch boxes with a minimalist and refined aesthetic, available in two shapes, square and rectangular.

The Weavers Home Fragrances capsule is a sophisticated selection of home fragrances, also by Simona Cremascoli. Available as a decorative candle and as a diffuser with sticks, the fragrance is encased in a leather-covered container with Motif Weavers Sage and Cinnamon geometric pattern combinations.

Lastly, Trusty is the line of small object holders designed by Poltrona Frau Style & Design Centre in three different sizes, stackable and with distinct nuances, in several color configurations.























↖ ↑ Happy Jack sofa, Botè fabric col.5 Silver Birch with base in Pelle Frau® ColorSphere® SC 22 Chiffon and Ruthenium feet

Archibald armchair, Haruka fabric col. 1307 light grey with gunmetal grey base a, Pelle Frau® ColorSphere® SC 176 Darsena with gunmetal grey feet





↑ Lepli 106×106 cm, Pelle Frau®  
ColorSphere® SC 176 Darsena

↗ Archibald sofa, Pelle Frau® ColorSphere®  
SC 176 Darsena with gunmetal grey feet









↑ Archibald armchair, Haruka fabric col. 1307 light grey with gunmetal grey base





➤ Holly floor lamp, Double Pearl lampshade







↖ ↑ Bob with drawer, ash in a moka stain top and  
burnished base  
Pad in Pelle Frau® ColorSphere® SC 29 Ardesia



↑ Bob 40×40 cm (square version), Canaletto walnut top with Ruthenium base





↑ Trusty small dresser caddy, Pelle Frau®  
SC 255 belladonna



↑ Sanluca armchair with ottoman, Pelle Frau® ColorSphere® SC 279 Alchemy

↗ Bob Ø45 h 53 cm, Pelle Frau® ColorSphere® SC 22 Chiffon with Ruthenium base

















↑ Letizia armchair, Pelle Frau® Velvety Grey Salt  
with black legs



↑ Ouverture sofa, Pelle Frau® Velvety Juniper  
Ikiperu 35×57 cm cushion, Earth Brown color



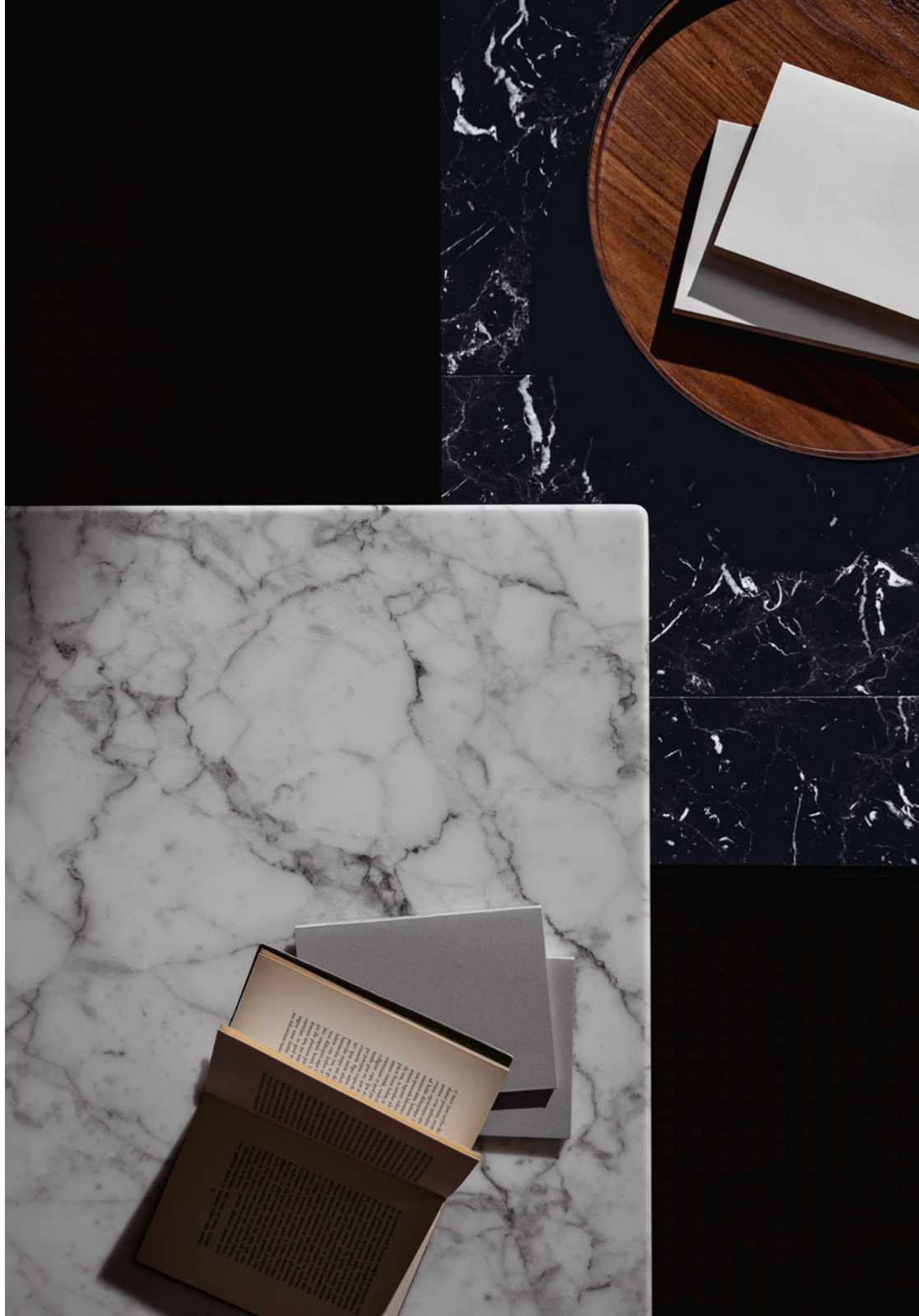

↑ Bob 60×60 cm (square version), brilliant Arabescato marble top with Ruthenium base







↑ ↗ Bob Ø60 h 43 cm, Pelle Frau® ColorSphere®  
SC 177 Limo with Ruthenium base  
Leather Pot small vase

↗ Club armchair, Ziggy fabric col.1374 Bleach Blue













↖ ↑ Ikiperu pyx, Sky Blue color  
Bob Ø45 h 52 cm, Pelle Frau® ColorSphere®  
SC 176 Darsena with Ruthenium base

Chester armchair, Pelle Frau® Velvety Sesamo



↑ ↗ Lepli 39×39 cm, Pelle Frau® Velvety Rosemary Lepli 39×39 cm, Pelle Frau® Velvety Juniper Lepli 39×39 cm, Haruka fabric col. 1307 light grey with belt in Pelle Frau® ColorSphere® SC 40 Cachemire

↗ Dido Lamp, Dark blue grey lampshade Water Illusion vase, Moon Bounces color Ikiperu pyx, Sky Blue color; Lepli 39×39 cm, Pelle Frau® Velvety Rosemary; Fidelio Console, Saddle Extra leather Corda with ash in a moka stain structure







↑ Dido Lamp, Dark blue grey lampshade  
Ikiperu pyx, Sky Blue color





↑ Water Illusion vase, Moon Bounces color



↑ Fascination small leather watch box, Pelle Frau®  
SC 279 Alchemy

↗ 1919 armchair, Pelle Frau® Velvety Juniper









↑ Trusty medium dresser caddy, Pelle Frau®  
Motif Weavers Sage





↑ Weavers Home Fragrance candle, Pelle Frau® Motif Weavers Sage with "Pink Pepper Touch" fragrance



↑ Weavers Home Fragrance diffuser, Pelle Frau® Motif Weavers Sage with “Pink Pepper Touch” fragrance

↗ Ikiperu 47×47 cm cushion, Earth Brown color  
Vanity Fair XC armchair, Pelle Frau® ColorSphere® SC 48 Tonka











↑ Ikiperu 35×57 cm cushion, Sky Blue color



↑ Fascination small leather jewelry box, Pelle Frau®  
ColorSphere® 173 Glauco  
Fascination medium leather watch box, Pelle Frau®  
ColorSphere® SC 279 Alkemy

↑ Bob 60×60 cm (square version), brilliant Arabescato  
marble top with Ruthenium base  
↗ Archibald sofa, Haruka fabric col. 1307 light grey  
with gunmetal grey feet



















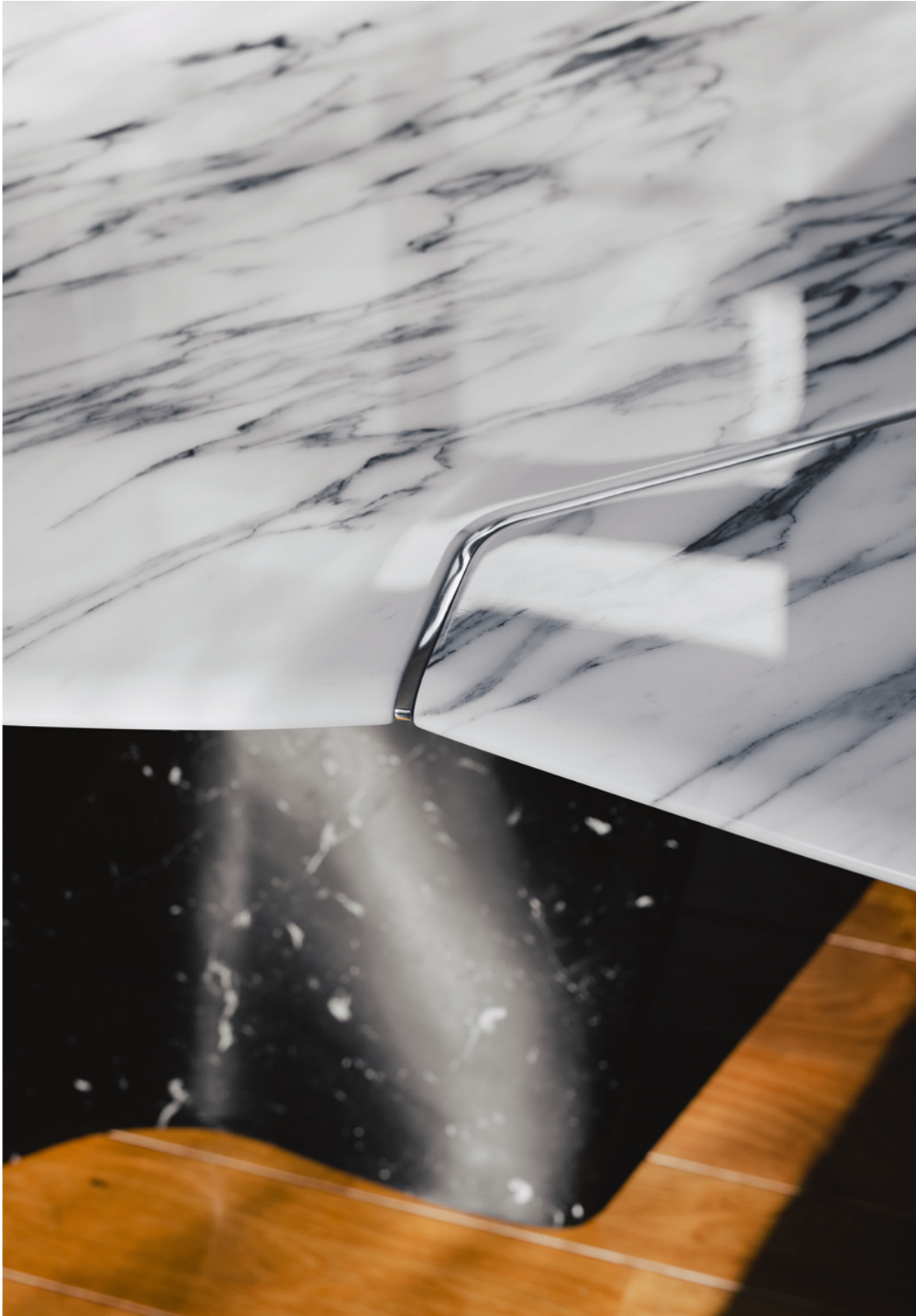

↖ Nice chair, Saddle Extra Corda with Guatemala fabric col. Ecrú and burnished legs

↖ ↑ Infinitamente 340×120 table, brilliant White Levigliani marble top with black Marquinia marble bases





↑ Infinitamente 340×120 table, brilliant White  
Levigliani marble top with black Marquina  
marble bases





↖ ↑ Nice chair, Saddle Extra Corda with Guatemala fabric col. Ecrú and burnished legs









↖ ↑ Fidelio Low cabinet 180×77 cm, Pelle Frau®  
Saddle avorio with brilliant Arabescato marble top  
and ash in a moka stain base

Ikiperu pyx, Sky Blue color  
Ikiperu vase, Earth Brown color  
Ikiperu cup, Earth Brown color





↑ Dido Lamp, Dark blue grey lampshade





↑ Fidelio Low cabinet 180×77 cm, Pelle Frau® Saddle avorio with brilliant Arabescato marble top and ash in a moka stain base

Ikiperu pyx, Sky Blue color  
Ikiperu vase, Earth Brown color  
Ikiperu cup, Earth Brown color



↑ ↗ Bob Bistrot Ø60 h 110 cm table, Arabescato marble top and burnished base

Montera Mas stool, Kvadrat Hallingdal 65 fabric col. 773 Blu and burnished legs

















↑ Trust small desk, Pelle Frau® ColorSphere® SC 22 Chiffon

Downtown Conference 5-spokes swivel base with castors, Pelle Frau® ColorSphere® SC 23 Tortora with black base



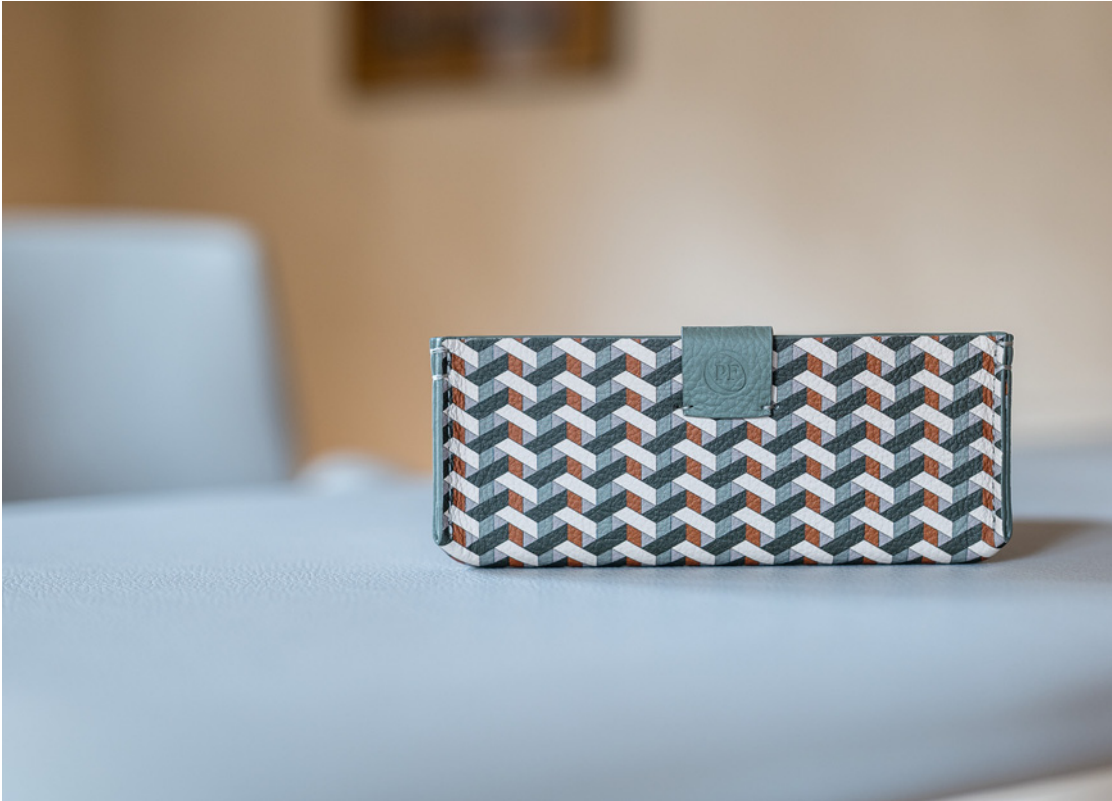

↑ Trusty medium dresser caddy, Pelle Frau®  
Motif Weavers Sage





↑ Ikiperu pyx, Earth Brown color  
Ikiperu vase, Sky Blue color  
Ikiperu cup, Sky Blue color









Archibald

↑ ↗ Archibald sofa, Gaban fabric col. 1 with titanium feet





# Jean-Marie Massaud Archibald









↖ ↑ Archibald sofa, Gaban fabric col. 1 with titanium feet











↑ Archibald King armchair, Smooth fabric col. Almond with gunmetal grey feet





↑ Archibald Large armchair, Smooth fabric col. Almond with gunmetal grey feet

# Jean-Marie Massaud Archibald



↑ Archibald Large armchair with ottoman, Smooth fabric col. Almond with gunmetal grey feet





↑ Archibald A armchair, Smooth fabric col. Almond with gunmetal grey feet



↑ Downtown Conference with 5-spokes swivel base  
with castors, Pelle Frau® ColorSphere® SC 23 Tortora





↑ Downtown Conference with 5-spokes swivel base  
with castors, Pelle Frau® ColorSphere® SC 23 Tortora

# Jean-Marie Massaud Downtown Conference







↑ Downtown Conference with 5-spokes swivel base  
with castors, Pelle Frau® ColorSphere® SC 23 Tortora







# Roberto Lazzeroni Montera Mas

↖ ↑ Montera Mas stool, Pelle Frau® ColorSphere® SC  
31 Quarzo Fumé and titanium legs







↖ ↑ Montera Mas stool, Pelle Frau® ColorSphere® SC  
31 Quarzo Fumé and titanium legs



↑ ↗ Montera Mas stool, Kvadrat Hallingdal 65 fabric  
col. 773 Blu and burnished legs







Poltrona Frau

↑ ↗ Infinitamente 340×120 table, brilliant White  
Levigiani marble top with black Marquinia  
marble bases



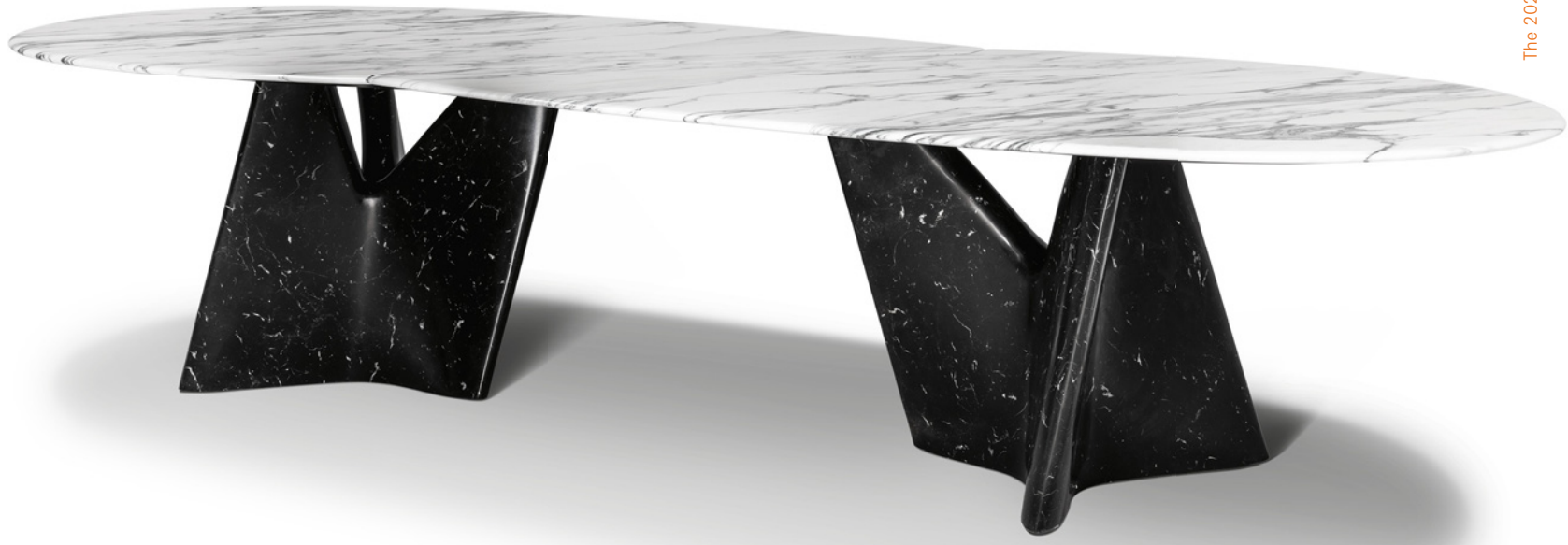

# Roberto Lazzeroni Infinitamente



↑ Detail of 340×120 top: a metal blade insert refines the joint between the two white Levigliani marble parts

↗ Detail of the white Levigliani marble top characterised by darker shades of grey crossed by light veins and little grey flecks









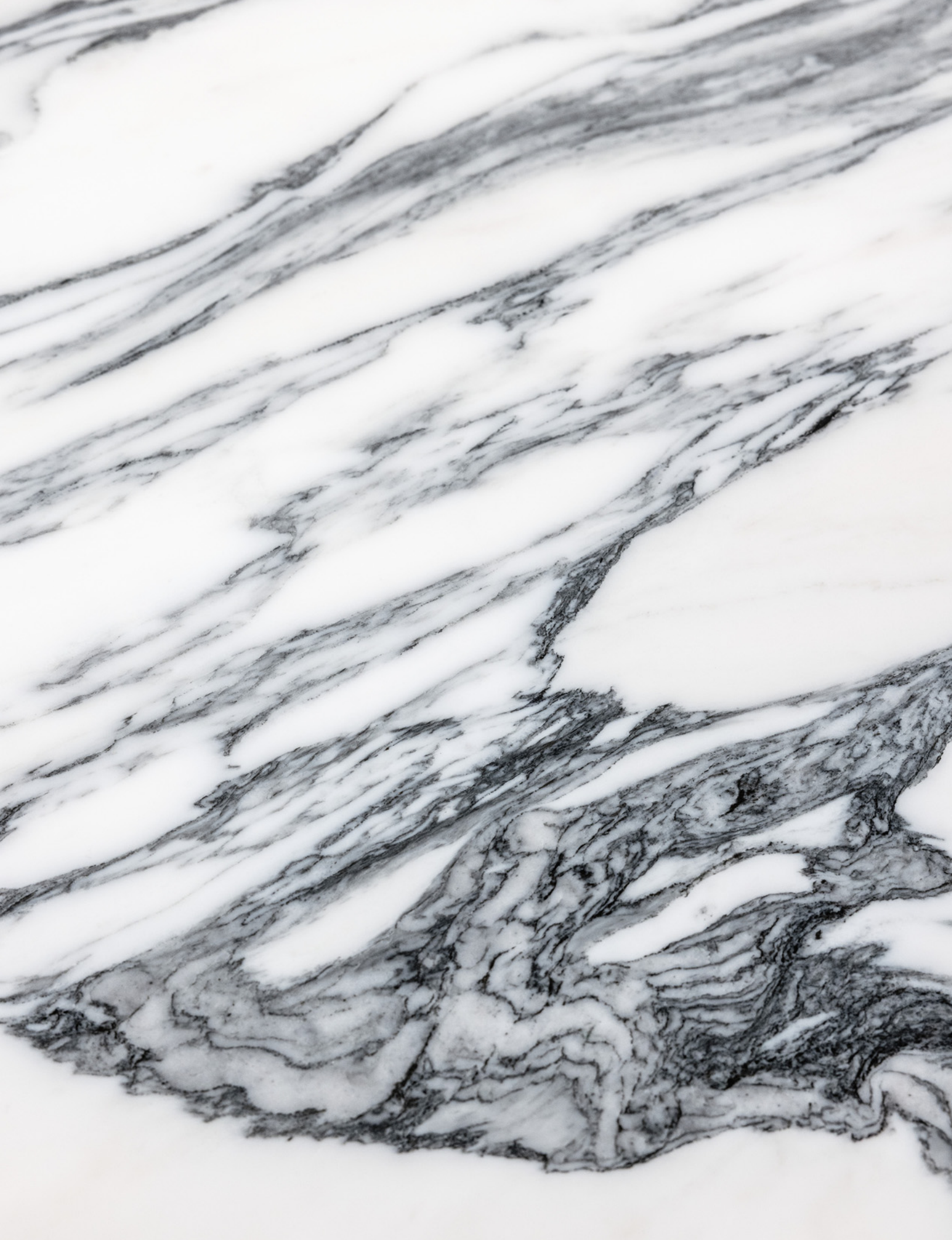



↑ ↗ Infitamente 220×124 table, brilliant White  
Levigiani marble top with black Marquinia  
marble base







↑ ↗ Fidelio Low cabinet 180×77 cm, Pelle Frau® Saddle avorio with brilliant Arabescato marble top and ash in a moka stain base





# Roberto Lazzeroni Fidelio Low Cabinet



↑ Detail of the marble top and of the Tone-on-tone stitching





↑ Detail of the door covered in Pelle Frau®  
Saddle avorio

Poltrona Frau



↑ Bob with drawer, ash in a moka stain top and burnished base. Pad in Pelle Frau® ColorSphere® SC 29 Ardesia





↑ Bob 40×40 cm (square version), Pelle Frau®  
ColorSphere® SC 06 Calicot top with  
Ruthenium base

# Jean-Marie Massaud Bob & Bob with drawer



↑ Detail of the Ruthenium base





↑ Bob with drawer, ash in a moka stain top and burnished base



↑ Ikiperu pyx, Earth Brown color  
Ikiperu vase, Sky Blue color



# Kristine Five Melvær Ikiperu Ceramics



↑ Ikiperu vase, Sky Blue color  
Ikiperu cup, Sky Blue color

↑ Ikiperu pyx, Sky Blue color



↑ Ikiperu vase, Sky Blue color





↑ Ikiperu cup, Sky Blue color  
Ikiperu pyx, Sky Blue color



↑ Ikiperu pyx, Earth Brown color  
Ikiperu cup, Earth Brown color





↑ Ikiperu vase, Earth Brown color





↑ Ikiperu 47×47 cm cushion, Earth Brown color



# Kristine Five Melvæer Ikiperu Patchwork Cushions

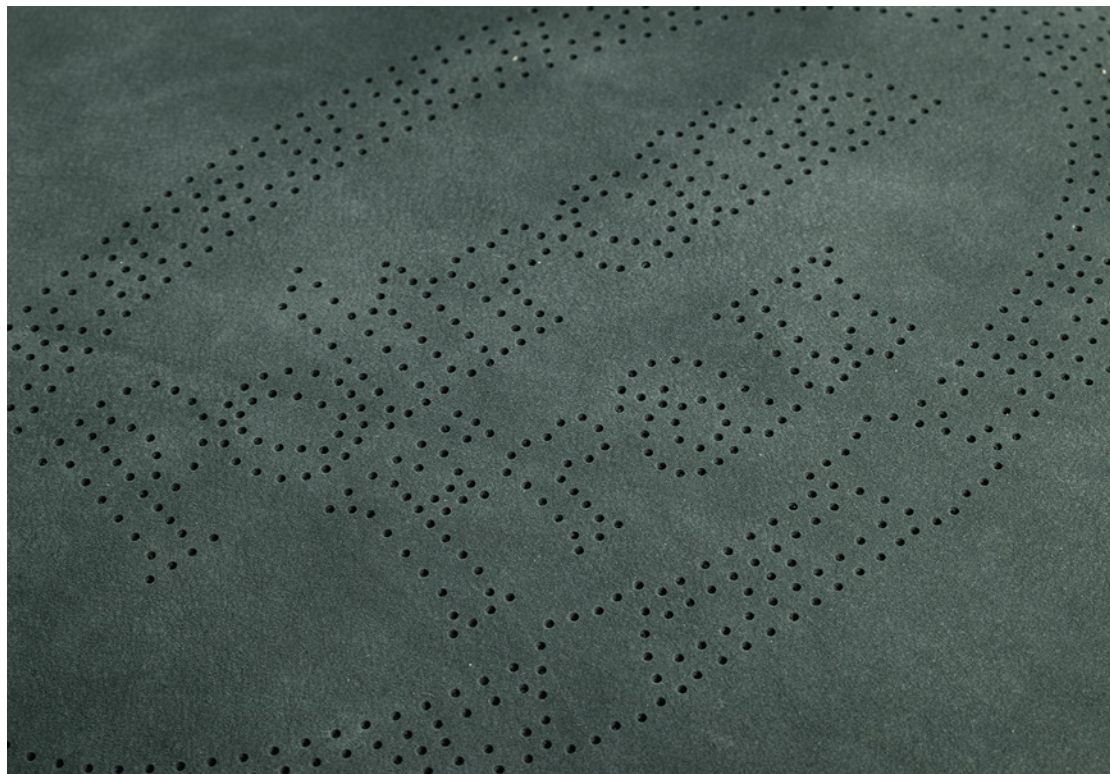

↑ Detail of the micro-perforated Poltrona Frau logo on the back of the cushion. The back is in Pelle Frau® Velvety leather Rosemary color (Earth Brown version)

↗ Ikiperu patchwork cushions











↑ Fede and Dido lamps, Dark blue grey lampshade

# Jean-Marie Massaud Le Lampade



↑ Detail of the rectangular removable trays in sand coloured micro-fibre

↗ Fascination medium leather jewelry box, Pelle Frau® ColorSphere® 173 Glauco





# Poltrona Frau Style & Design Centre Fascination







↖ ↑ Fascination medium leather watch box, Pelle Frau®  
ColorSphere® SC 279 Alkemy

↑ Detail of the removable tray



↑ Detail of the square removable tray  
in sand coloured micro-fibre

↗ Fascination small leather watch box, Pelle Frau®  
ColorSphere® SC 279 Alkemy





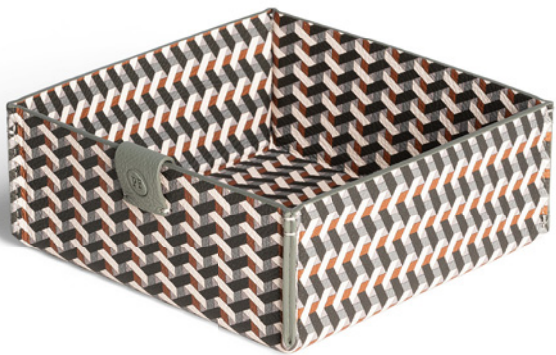

↑ Trusty medium dresser caddy, Pelle Frau® Motif Weavers Sage

Trusty small dresser caddy, Pelle Frau® ColorSphere® SC 31 Quarzo Fumé  
Trusty large dresser caddy, Pelle Frau® ColorSphere® SC 180 Celadon / SC 67 Chiodi di Garofano





# Poltrona Frau Style & Design Centre Trusty

↑ Trusty large dresser caddy, Pelle Frau® ColorSphere®  
SC 136 Ginger Bread / SC 31 Quarzo Fumè  
Trusty small dresser caddy, Pelle Frau® ColorSphere®  
SC 255 Belladonna

Trusty medium dresser caddy, Pelle Frau®  
Motif Weavers Cinnamon



↑ Detail of the raw cut edging in SC 67 Chiodi di Garofano color provided for the large dresser caddy in SC 180 Celadon

↗ Stackable dresser caddies







↑ Weavers Home Fragrance candle, Pelle Frau® Motif  
Weavers Sage with “Pink Pepper Touch” fragrance

↗ Weavers Home Fragrance diffuser, Pelle Frau® Motif  
Weavers Sage with “Pink Pepper Touch” fragrance





# Simona Cremascoli Weavers Home Fragrance



↑ Weavers Home Fragrance diffuser, Pelle Frau® Motif Weavers Cinnamon with “Saffron Breeze” fragrance

↗ Detail of the leather lead of the Weavers Home Fragrance candle (Pelle Frau® Motif Weavers Sage / Pelle Frau® ColorSphere SC 66 India version)





# Pleasure of Writing

## Pineider x Poltrona Frau

Pelle Frau® finds new shapes in an elegant set of writing accessories co-signed with historic luxury stationery brand Pineider.

Poltrona Frau and Pineider invite to discover the Pleasure of Writing, celebrating the manual gesture of the hand putting words on paper.



The Pineider x Poltrona Frau collection is the meeting point of two excellences marked by a rich history, whose partnership reveals a collection of objects that communicate innovative design and manufacturing excellence. The collection consists of a set of objects that make writing a moment of exquisite relaxation: two notebooks bound in soft Pelle Frau® leather, an elegant notepad holder, and a rollerball pen with a stem in Pelle Frau® leather finely crafted by Pineider, all in two colors.



↑ A4 Notepad holder, Pelle Frau® Motif  
Weavers Sage / ColorSphere® SC 180 Celadon.  
Detail of the interior



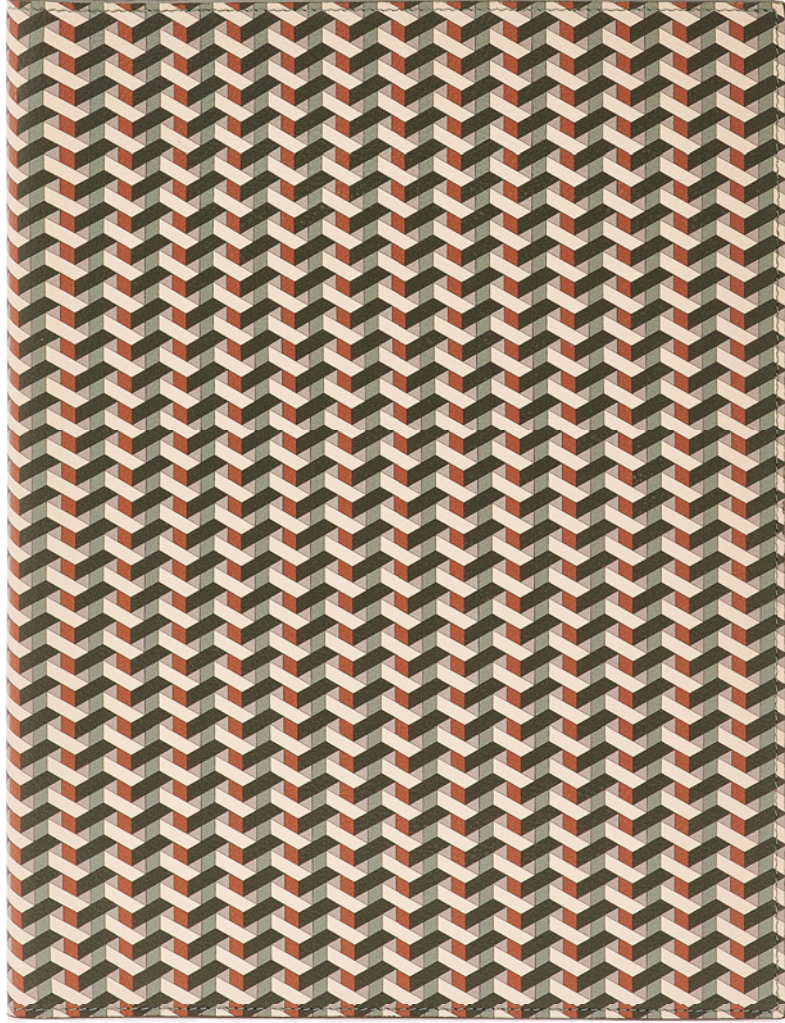

↑ A4 Notepad holder, Pelle Frau® Motif  
Weavers Sage / ColorSphere® SC 180 Celadon

# Pineider x Poltrona Frau A4 Notepad holder

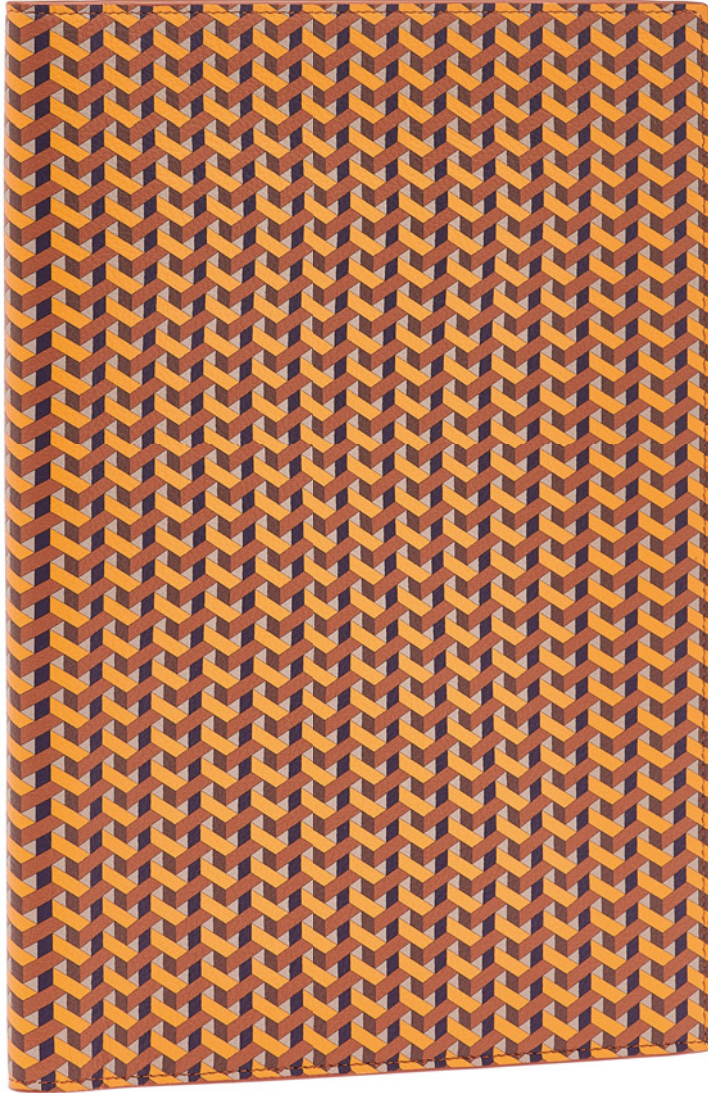

↑ A4 Notepad holder, Pelle Frau® Motif Weavers  
Cinnamon / ColorSphere® SC 66 India





↑ A4 Notepad holder, Pelle Frau® Motif Weavers  
Cinnamon / ColorSphere® SC 66 India.  
Detail of the document holder pocket

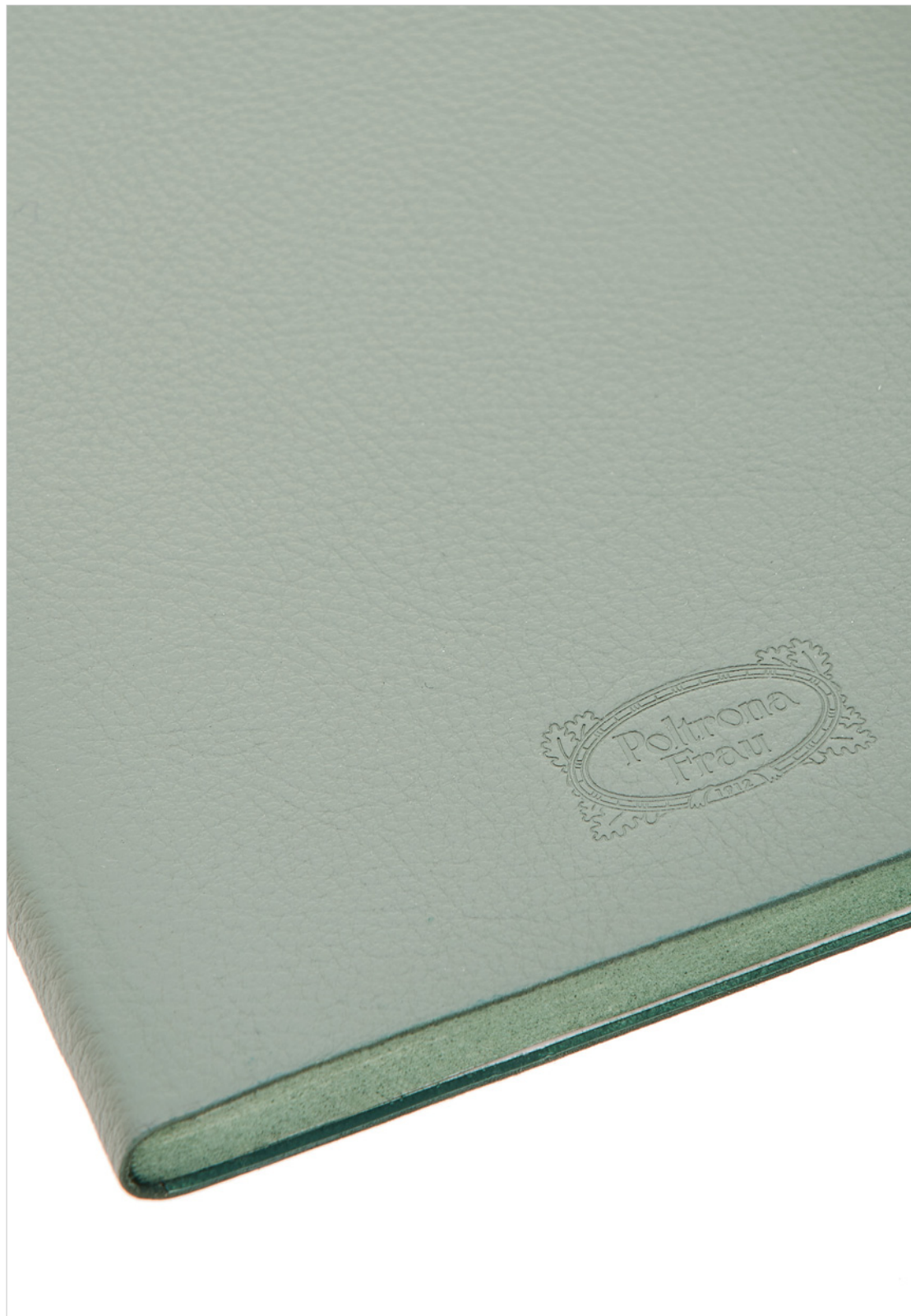

↑ 14,5×21 cm Notebook, Pelle Frau® ColorSphere®  
SC 180 Celadon. Detail of the Poltrona Frau logo  
impressed on the cover



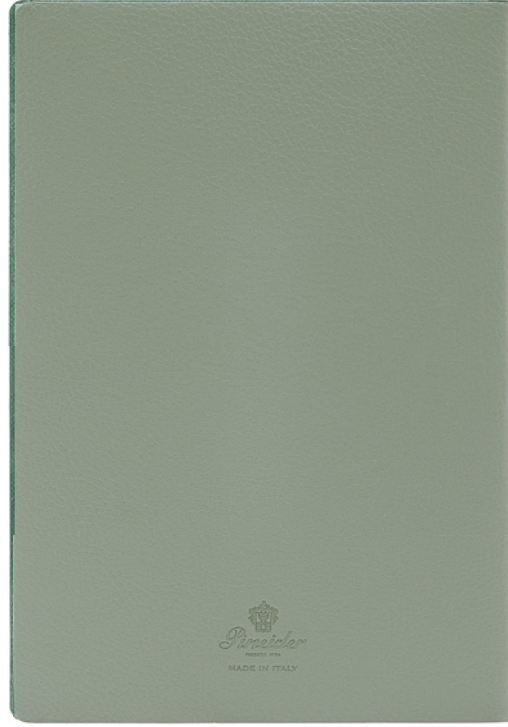

↑ 14,5×21 cm Notebook, Pelle Frau® ColorSphere®  
SC 180 Celadon

# Pineider x Poltrona Frau Notebook







↑ Rollerball pen with leather detail in Pelle Frau®  
ColorSphere® SC 180 Celadon

# Pineider x Poltrona Frau Rollerball pen





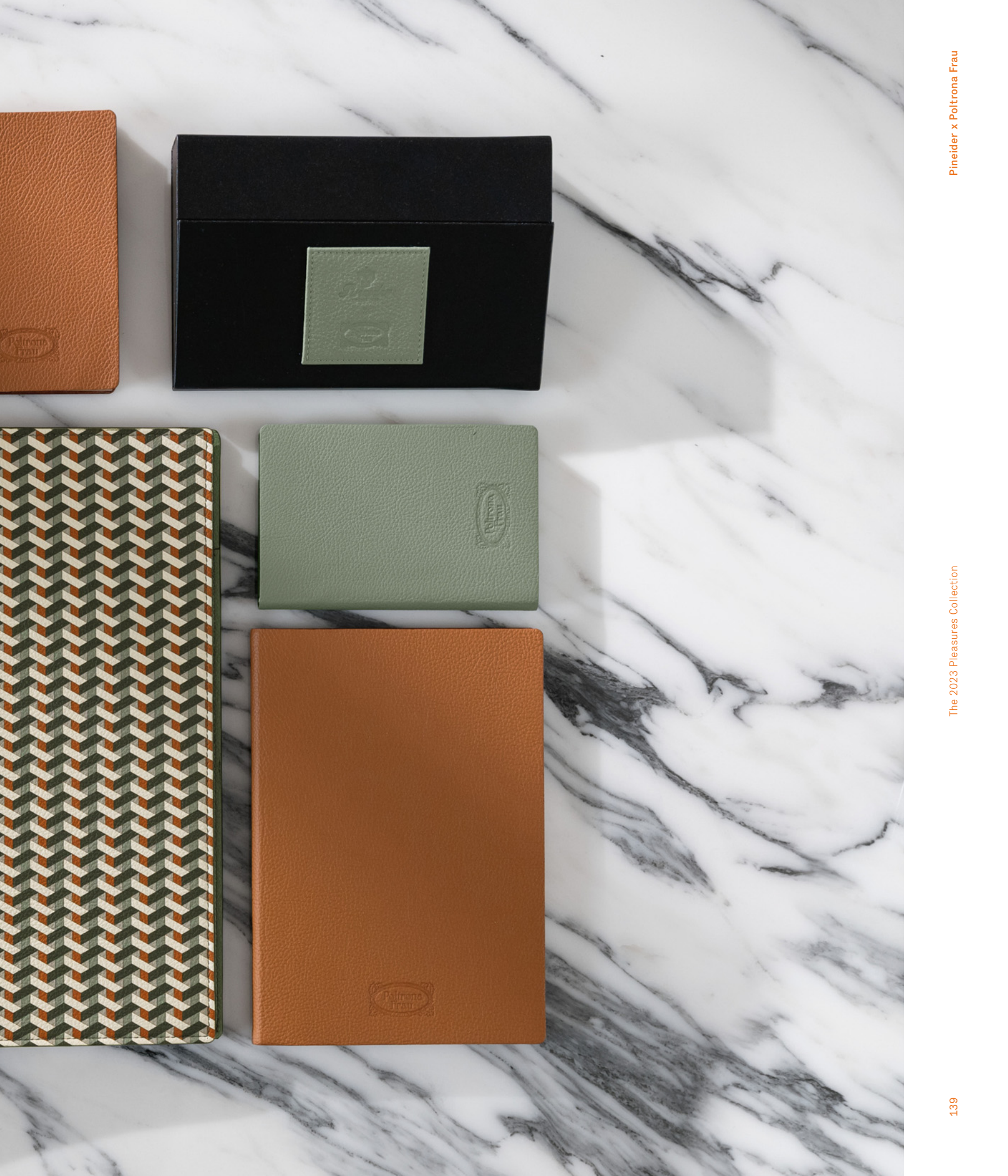





↑ Rollerball pens with leather detail in Pelle Frau® ColorSphere® SC 180 Celadon and SC 66 India

9×14 cm Notebook, Pelle Frau® ColorSphere® SC 180 Celadon





↑ Detail of the SC 180 Celadon leather label applied on the Rollerball pen case







↑ A4 Notepad holder, Pelle Frau® Motif Weavers Sage / ColorSphere® SC 180 Celadon

Rollerball pen, Pelle Frau® ColorSphere® SC 66 India





## Translations

- 146 Italian Translation
- 146 French Translation
- 147 Chinese Translation

## Pleasure of Comfortable Living

- 148 Archibald
- 148 Bob & Bob with drawer
- 150 Downtown Conference
- 150 Fascination
- 151 Fidelio Low Cabinet
- 152 Ikiperu Ceramics
- 153 Ikiperu Patchwork Cushions
- 153 Infitamente
- 154 Le Lampade
- 155 Montera Mas
- 156 Trusty
- 157 Weavers Home Fragrance

## Pleasure of Writing Pineider x Poltrona Frau

- 158 A4 Notepad holder
- 158 Notebook
- 158 Rollerball pen

# Translations and Technical Drawings

IT

**Poltrona Frau presenta la 2023 Pleasures Collection, che raccoglie le novità di prodotto nel segno del piacere:** il piacere di circondarsi di oggetti che raccontano storie, trasmettono emozioni ed elevano l'esperienza del vivere contemporaneo. Novità di prodotto e ampliamenti di gamma, tutti contraddistinti da un inconfondibile stile essenziale e raffinato, concorrono a modellare nuovi stili abitativi dove l'esperienza umana diventa protagonista. Il piacere di abitare gli spazi, farli propri e personalizzarli secondo le proprie vocazioni estetiche trova espressione in una serie di arredi e complementi caratterizzati dall'inconfondibile eleganza essenziale e senza tempo di Poltrona Frau.

Il tavolo-scultura **Infinitamente** rappresenta la continuazione dello studio artistico sul marmo iniziata da **Roberto Lazzeroni** con il tavolo di grande successo dello scorso anno "Infinito ∞". Proposto in edizione limitata, il tavolo **Infinitamente** è interamente realizzato in marmo (Bianco Levigliani per il top, Nero Marquinia per i basamenti), in una esaltazione della forma che si concretizza nella complessa e accurata lavorazione dei blocchi di marmo. **Infinitamente** è disponibile in due misure, più compatto con top a ovale e basamento singolo, oppure più imponente con piano a doppio ovale sfalsato e basamento doppio. Le proprietà intrinseche del marmo fanno sì che ogni esemplare abbia un aspetto unico nelle aree di luminosità, nelle venature e nelle sfumature cromatiche.

Poltrona Frau rilegge alcune icone del proprio catalogo nel segno del comfort e della funzionalità, proponendo ampliamenti di gamma e restyling. Le sedute **Montera** e **Montera Mas**, ideate da **Roberto Lazzeroni**, si arricchiscono di nuove versioni: lo sgabello con gambe in metallo per **Montera**; e i nuovi sgabelli con gambe in metallo e in legno e la base con colonna per l'ultima versione di **Montera Mas**. La seduta imbottita può essere rivestita in tutta pelle o in tessuto sfoderabile.

La poltrona home-office **Downtown Conference** di **Jean-Marie Massaud** si rinnova con il nuovo basamento a cinque razze con ruote.

**Archibald**, l'iconica poltrona disegnata da **Jean-Marie Massaud** ed entrata nella memoria collettiva grazie alla riconoscibilità del rivestimento mosso in pelle e dei braccioli piegati, diventa protagonista di un'estensione di gamma con il nuovo modello a **divano a due posti**, un nuovo rivestimento in tessuto sfoderabile e una nuova finitura verniciata titanio per il basamento e le gambe.

La collezione di tavolini **Bob** ideati da **Jean-Marie Massaud** si arricchisce di due nuovi modelli e una nuova finitura: in versione con top quadrato, disponibile in varie misure; con cassetto inte-

grato al piano, ideale come comodino; con il top in Marmo Nero Marquinia.

Il mobile contenitore **Fidelio**, sistema storage capiente e dal segno grafico spiccato con la firma di **Roberto Lazzeroni**, viene presentato in una nuova edizione compatta di 180cm di lunghezza. Restano invariate l'essenzialità formale e finiture sofisticate, per una collezione trasversale e facilmente abbinabile a tutti gli altri arredi Poltrona Frau.

L'offerta di illuminazione di Poltrona Frau si arricchisce grazie alle nuove forme e colorazioni dei paralumi per le collezioni **Holly**, **Fede** e **Dido**, di design di **Jean-Marie Massaud**. Le lampade, che si caratterizzano per l'elegante lavorazione del vetro soffiato, sono oggi ancora più contemporanee grazie ai nuovi paralumi in tessuto nelle eleganti cromie pearl, stone e dark blue/grey. La maestria di Poltrona Frau nel creare ambienti scenografici dal fascino senza tempo si rivela anche nella selezione dei complementi, oggi ampliata da quattro nuove linee di prodotto.

La designer norvegese **Kristine Five Malvaer** dà un'interpretazione pop e contemporanea all'arte della decorazione con la nuova collezione **Ikiperu**, che prende il nome dall'antica divinità etrusca dell'acqua e della fertilità Cupra, archetipo delle forme femminili e dell'abbondanza. La collezione si compone di un **vaso**, una **ciotola** e un **piccolo recipiente con coperchio** in ceramica umbra dall'aspetto grafico pronunciato, con contrasti creati dalle diverse fasce di colore e dalla diversa texture delle aree smaltate e non smaltate. Completa la serie **Ikiperu** una linea di **cuscini** che esalta il rivestimento in Pelle Frau Velvety in doppio colore e riprende nei patchwork geometrici gli stessi raggi di curvatura dei vasi.

La lavorazione artistica della pelle è protagonista anche delle tre nuove linee di oggetti **Fascination**, **Trusty** e **Weavers Home Fragrances**.

**Fascination**, creata dal **Poltrona Frau Style & Design Centre**, è il set di scatole portagioie e portaorologi rivestite in pelle dall'estetica essenziale e raffinata, disponibile in due dimensioni, quadrata e rettangolare.

Una ricercata selezione di fragranze per ambienti è rivelata nella capsula **Weavers Home Fragrances**, anche questa con la firma di **Simona Cremascoli**. Declinata in forma di candela decorativa e di diffusore per ambienti con bastoncini, la fragranza è racchiusa in un contenitore rivestito in pelle con i raffinati motivi geometrici nelle combinazioni Motif Weavers Sage e Cinnamon.

Infine **Trusty** è la linea di contenitori svuotatasche ideata dal **Poltrona Frau Style & Design Centre** in tre diverse grandezze, impilabili e dalle nuance spiccate, in diverse configurazioni di colore.

Pleasure of writing

**Pineider x Poltrona Frau**

La **Pelle Frau**® trova una nuova forma nell'elegante set di accessori per la scrittura co-firmato con lo storico brand di cancelleria di lusso Pineider. Poltrona Frau e Pineider invitano a scoprire il piacere di scrivere, ritrovando il gesto manuale del trasformare il pensiero in parola. La collezione **Pineider x Poltrona Frau** rappresenta il punto di incontro di due realtà contraddistinte da un ricco percorso storico, il cui connubio si rivela in una linea di prodotti che trasmettono l'innovazione della progettualità e l'eccellenza della produzione. La collezione consiste in un set di oggetti che rendono la scrittura un momento di raffinato relax: due **taccuini** rilegati in morbida Pelle Frau®, un elegante **portablocco**, una **penna roller** con stelo in Pelle Frau® finemente lavorata da Pineider, il tutto in due colorazioni.

FR

**Poltrona Frau présente la 2023 Pleasures Collection qui accueille toutes les nouveautés produit sous le signe du plaisir:** le plaisir de s'entourer d'objets qui racontent des histoires, transmettent des émotions et élèvent l'expérience du vivre contemporain. Les nouveautés produit et les extensions de gamme, tous caractérisés par un style incomparable qui se veut essentiel et raffiné, participent à forger de nouveaux styles d'habitation où l'expérience humaine devient la protagoniste. Le plaisir d'habiter les espaces, de se les approprier et de les personnaliser au gré de ses envies esthétiques trouve le summum de son expression dans une série de meubles et d'accessoires caractérisés par l'élégance épurée et intemporelle incomparable de Poltrona Frau.

La table-sculpture **Infinitamente** constitue la continuation de l'étude artistique du marbre initiée par **Roberto Lazzeroni** avec la table à succès de l'année dernière « Infinito ∞ ». Proposée en édition limitée, la table **Infinitamente** est entièrement réalisée en marbre (Blanc Levigliani pour le plan, Noir Marquinia pour les piétements), une exaltation de la forme qui se traduit par un travail des blocs de marbre complexe et méticuleux. **Infinitamente** est disponible dans deux tailles, une plus compacte avec le plan ovale et un piétement unique, une plus imposante avec un double plan ovale en porte-à-faux et un double piétement. Les propriétés intrinsèques du marbre font que chaque exemplaire a un aspect unique dans les zones de luminosité, dans les veines et dans les nuances de couleur.

Poltrona Frau réinterprète quelques-unes de ses icônes de son catalogue en les plaçant sous le signe du confort et de la fonctionnalité, le tout décliné dans tout un assortiment de produits et de restyling. Les assises **Montera** et **Montera Mas**, inventées par **Roberto Lazzeroni** s'enrichissent de nouvelles versions : le tabouret aux pieds en métal pour **Montera** et les nouveaux tabourets aux pieds en métal et en bois et avec la base avec colonne pour la toute dernière version de **Montera Mas**. L'assise rembourrée peut être revêtue toute en cuir ou en tissu déhoussable.

Le fauteuil de bureau à la maison **Downtown Conference** de **Jean-Marie Massaud** se pare d'un nouveau piétement à cinq branches et de roulettes.

**Archibald**, le fauteuil emblématique signé **Jean-Marie Massaud** et entré dans la mémoire collective grâce au revêtement original mouvementé en cuir et à ses accoudoirs pliés, devient le protagoniste d'une extension de gamme avec le nouveau modèle de **canapé à deux places**, un nouveau revêtement en tissu déhoussable et une nouvelle



finition peinte Titanio pour le piétement et les pieds.

La collection de tables basses **Bob** imaginée par **Jean-Marie Massaud** s'enrichit de deux nouveaux modèles et d'une nouvelle finition : avec la version composée d'un plan carré, disponible dans différentes tailles ; avec tiroir incorporé dans le plan, l'idéal pour servir de table de chevet, avec le plan en marbre Noir Marquina.

Le meuble **Fidelio**, un système de rangement d'une grande capacité et au signe graphique remarquable avec la signature de **Roberto Lazzeroni**, est présenté dans une nouvelle édition compacte de 180 cm de longueur. En revanche, le caractère épuré des formes et les finitions sophistiquées demeurent inchangées pour une collection transversale et facile à associer à tous les autres meubles Poltrona Frau.

L'offre d'éclairage de Poltrona Frau s'enrichit grâce aux nouvelles formes et couleurs des abat-jour pour les collections **Holly**, **Fede** et **Dido** de design signés **Jean-Marie Massaud**. Les lampes qui se caractérisent par l'élégant travail du verre soufflé sont aujourd'hui encore plus contemporaines grâce aux nouveaux abat-jour en tissu déclinés dans les couleurs raffinées Pearl, Stone et Dark Blue/Grey. Le savoir-faire magistral de Poltrona Frau à savoir créer des environnements spectaculaires au charme intemporel se révèle aussi dans la sélection d'accessoires, enrichie aujourd'hui de quatre nouvelles lignes de produit.

La designer norvégienne **Kristine Five Malvaer** offre une interprétation pop et contemporaine de l'art de la décoration avec la nouvelle collection **Ikiperu** qui tire son nom de l'antique divinité étrusque de l'eau et de la fertilité Cupra, archétype des formes féminines et de l'abondance. La collection se compose d'un **vase**, d'une **coupelle** et d'un **petit récipient avec couvercle** en céramique d'Ombrie à l'aspect graphique prononcé, rehaussé de contrastes créés par les différentes bandes de couleur et la texture différenciée des zones émaillées et non émaillées. La série **Ikiperu** est accompagnée d'une ligne de **coussins** qui sublime le revêtement en cuir Pelle Frau Velvety en double couleur et reprend, dans les patchworks géométriques, les rayons de courbure identiques à ceux des vases.

Le travail artistique du cuir est protagoniste aussi trois nouvelles lignes d'objets **Fascination**, **Trusty** et **Weavers Home Fragrances**.

**Fascination**, créé par le **Poltrona Frau Style & Design Centre**, est l'ensemble de coffrets à bijoux et à montres revêtus de cuir au style épuré et raffiné, disponible dans deux formes différentes, carrée ou rectangulaire.

Une sélection attentive de parfums d'ambiance se traduit par la création de la capsule **Weavers Home Fragran-**

**ces**, elle aussi portant la signature de **Simona Cremascoli**. Décliné en bougie décorative et diffuseur d'ambiance avec bâtonnets, le parfum est contenu dans un récipient revêtu de cuir, rehaussé de motifs géométriques raffinés dans les combinaisons Motif Weavers Sage et Cinnamon.

Enfin, **Trusty** est la ligne de récipients vide-poches créée par le **Poltrona Frau Style & Design Centre**, déclinée dans trois grandeurs différentes, empilables et aux nuances vives à choisir parmi trois couleurs.

**Pleasure of writing Pineider x Poltrona Frau**

Le cuir **Pelle Frau®** y découvre une nouvelle forme dans l'élégant ensemble d'accessoires pour l'écriture signé en collaboration avec la marque historique de bureautique de luxe Pineider. Poltrona Frau et Pineider invitent à découvrir le plaisir d'écrire en retrouvant ce geste manuel qui permet de transformer une pensée en mots. La collection **Pineider x Poltrona Frau** représente le point d'union de deux réalités démarquées par un riche parcours historique, dont la conjugaison prend vie à travers une ligne de produits qui transmettent l'innovation du projet et l'excellence de la production. La collection consiste en un ensemble d'objets qui rendent l'écriture un moment de détente raffinée : deux carnets avec reliure faits du cuir souple Pelle Frau®, un élégant **porte-blocs**, un **stylo** à bille avec manche en cuir Pelle Frau® finement travaillé par Pineider, le tout existant dans deux coloris.

**ZH**

Poltrona Frau 2023 Pleasures系列以“悦”之名开启全新创意旅程，透过日常生活中的匠心之物讲述动人故事，传递充沛情感，令现代生活体验更加精彩纷呈。此次发布的新品及系列拓展产品均秉持简约、独特而不失精致的设计风格，全心缔造以人为本的生活新风尚。

Poltrona Frau家具和配饰简约典雅、个性出众，可根据个人审美理念量身打造心仪空间，让人乐享愉悦生活。去年，Roberto Lazzeroni设计的“Infinito ∞”桌大获成功，由此开启设计师对大理石的不懈钻研，极具雕塑感的Infinitamente桌便是对此美学研究的延续。限量版Infinitamente桌完全由大理石制成，桌面选用Levigliani白色大理石，底座选用马奎尼亚黑大理石，淋漓展现复而精妙的匠心工艺。Infinitamente有两种尺寸可供选择，小号采用单椭圆形桌面，配备单底座；大号则采用交错双椭圆形桌面，配备双底座。每张桌子的亮度、纹理及色调各不相同，塑就独特外观，将大理石的天然特性展露无遗。

Poltrona Frau对部分经典作品加以重释，追求舒适体验与实用功能，在拓展系列的同时，塑造崭新风格。由Roberto Lazzeroni设计的Montera座椅和Montera Mas座椅再添新作，推出带金属椅腿的Montera吧椅，以及配备金属或木质椅腿或可调节底座的新款Montera Mas吧椅。座面既可搭配皮革套面，亦可选用可拆卸布艺套面。

带滑轮的全新五辐条底座，令Jean-Marie Massaud设计的Downtown Conference居家办公椅焕发新意。

Jean-Marie Massaud设计的经典Archibald扶手椅凭借别具个性的波纹套面及折叠扶手，给大众留下了深刻印象。此次推出新款二人位沙发，配以全新可拆卸布艺套面，底座和支腿均采用全新钛金属喷漆饰面，进一步拓展该系列。

同样出自Jean-Marie Massaud之手的Bob咖啡桌系列推出两款新作和一种全新饰面：一个新款配以方形桌面，有多种尺寸可选；另一新款配有一体式抽屉，适合作为床头柜使用；桌面选用Marquina黑色大理石。

Roberto Lazzeroni设计的Fidelio储物橱柜以充裕容量和鲜明风格著称，此次推出长180厘米的小号新款。新款沿袭原版作品的简约设计与精致饰面，可轻松搭配其他Poltrona Frau家具产品，成就灵活百搭的家具系列。

Poltrona Frau Holly、Faith及Dido灯具系列由Jean-Marie Massaud倾心设计，此次亦推出新款造型及灯罩色调，令系列更臻丰富。灯具采用精湛吹制玻璃工艺，呈现优雅格调，现推出全新布艺灯罩，选用珍珠白、石色以及深蓝/灰色等雅致色调，倍添现代气息。

Poltrona Frau擅长打造融蕴典雅魅力的优美环境，这一出众能力在四个全新配饰系列中也得到充分体现。

挪威设计师Kristine Five Malvaer将流行与现代元素融入全新Ikiperu系列之中。

系列命名源于古老伊特鲁里亚文化中象征水与生育的女神库帕拉（Cupra），她为系列作品的柔美形态与丰富款式提供了丰沛的灵感。此系列包含一款花瓶、一款碗以及一款带盖小瓶，均以翁布里亚陶瓷制成，外观生动醒目。上釉和未上釉部位呈现不同色带与纹理，巧妙玩转视觉与触觉对比。Ikiperu系列还包含多款靠垫，呼应陶瓷作品的几何造型，令Pelle Frau® Velvety双色拼接套面更显精致考究。

精妙皮革工艺亦是全新Fascination、Trusty以及Weavers Home Fragrances系列的焦点所在。

Fascination系列由设计师Poltrona Frau风格设计中心精心打造，推出一系列以皮革包覆的精美珠宝盒与腕表盒，风格简约精致，有方形和矩形两种造型可供选择。

Weavers Home Fragrances精选系列同样由Simona Cremascoli担纲设计，推出装饰蜡烛和配有扩香条的香氛器等一系列精致家用香氛作品，盛放香氛作品的容器包覆精美皮革，并饰以鼠尾草绿配肉桂色Motif Weavers几何图案。

Trusty小物容器系列由Poltrona Frau风格设计中心精心打造，推出三种不同尺寸，可堆叠使用，细节精妙别致，配色缤纷多样。

Pleasures of Writing书写之悦

Pineider x Poltrona Frau

与此同时，品牌携手历史悠久的高端文具品牌Pineider，以Pelle Frau®皮革焕然呈现书写配件。

Poltrona Frau和Pineider诚邀您探索书写之愉悦，弘扬于纸端酣畅挥洒的书写传统。Pineider x Poltrona Frau联名系列融合两大品牌优势，在彰显品牌深厚底蕴的同时，将创新设计与卓越工艺融入双方合作打造的匠心之物中。该系列旨在营造精致轻松的书写体验，包括两款以柔软Pelle Frau®皮革为封面的笔记本、一款优雅的记事本保护套以及一款中性笔，笔杆由Pineider以Pelle Frau®皮革精制而成，三款精品文具均推出两种颜色可选。

# A - B

## Archibald — 2-seater sofa

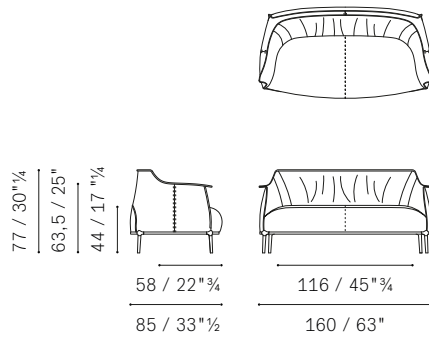

## Archibald — Finishes

**Base.** Four cast aluminium feet connected to a tubular steel frame, available in two finishes:

- gunmetal grey finish
- burnished finish
- titanium finish

**Upholstery.**

- ColorSphere® (SC)
- Nest
- Soul
- Velvety
- Fabric A
- Fabric B
- Fabric C
- C.O.M.

**Removability.** Prevista solo per la versione in tessuto.

**Aesthetic details.** Contrasting stitching along the edges and on the external surfaces of the leather upholstery. Tone-on-tone stitching for the fabric version.

## Bob — Coffee table 40×40 h 43 | wood or leather

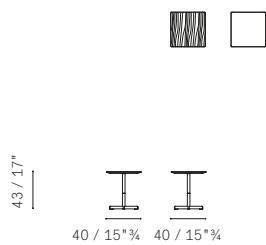

## Bob — Coffee table 40×40 h 43 | marble

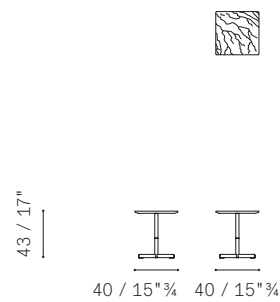

## Bob — Coffee table 40×40 h 52 | wood or leather

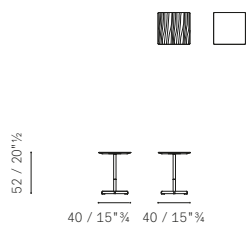

## Bob — Coffee table 40×40 h 52 | marble

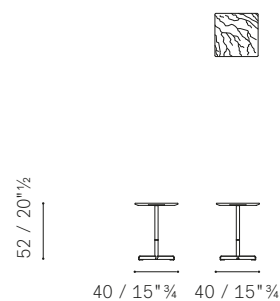



**Please note:**

this catalogue shows only some technical drawings, in order to know all the availabilities please refer to the current price list.

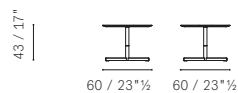
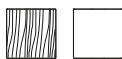
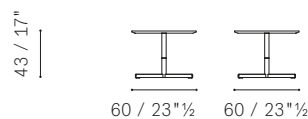
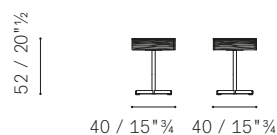
**Bob** — Coffee table 60×60 h 43 | wood or leather**Bob** — Coffee table 60×60 h 43 | marble**Bob with drawer** — Small table or Night table**Bob** — Finishes**Items.**

- 40×40 h 52
- 40×40 h 43
- 60×60 h 43

**Base and lower part of the leg.** In steel, available in the finishes:

- gunmetal
- ruthenium
- burnished

Protective plastic caps.

**Upper part of the leg.** In steel with collar with Canaletto Walnut veneer (29) when the top is in Canaletto Walnut, or upholstered in Pelle Frau® leather when the top is in leather or marble.

**Top.** Available in:

- Pelle Frau® ColorSphere® leather
- Canaletto Walnut (29)
- Marble
  - Brilliant Calacatta marble
  - Semi-brilliant Calacatta marble
  - Brilliant (veined) Arabescato Venato marble
  - Semi-brilliant (veined) Arabescato Venato marble
  - Brilliant Black Marquina marble
  - Semi-brilliant Black Marquina marble

**Bob with drawer** — Finishes

**Top and upper structure.** In moka (61) stained solid Ash.

**Base and leg.**

- burnished
- gunmetal grey

**Drawer.** Made of maple chip-board with extra clear natural maple wood finish (65) with a moka stained solid ash front.

**ACCESSORIES AND OPTIONALS**

Top leather pad.

- ColorSphere® (SC)
- Nest
- Soul

**Drawer pad in Alcantara®.**

In beige Alcantara as a form of decoration and protection for the drawer with a non-slip fabric on the bottom in contact with the interior of the drawer.

# D - F

## Downtown Conference — 5-spokes swivel armchair with castors

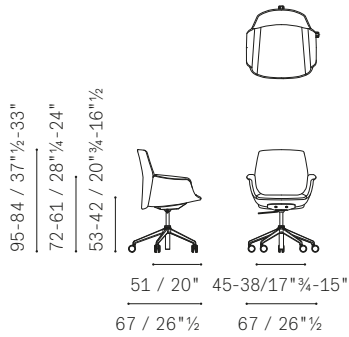

## Downtown Conference — Finishes

### Upholstery.

- ColorSphere® (SC)
- Nest
- Soul
- Fabric A
- Fabric B
- Fabric C
- C.O.M.

### Base finish.

- Black painted steel
- Chrome-plated steel

### Undershell cover.

- leather matching the shell upholstery
- finely embossed ABS plastic

### Supports.

- "W" type soft self-braking swivel wheels (advisable for granite, ceramic, marble, wood and linoleum floors)
- "H" type hard self-braking swivel wheels (for wall to wall carpeting and rugs)
- Revolving guides in thermoplastic materials with teflon protection caps suitable for all surfaces

### Functions.

- > 360° rotation
- > Gas spring seat height adjustment
- > Backrest and seat tilting and rocking with the option of limiting and regulating the rocking strength thanks to a rocking mechanism with an end stop.

## Fascination — Leather jewelry medium box

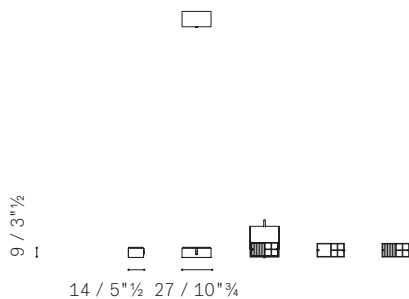

## Fascination — Leather jewelry small box

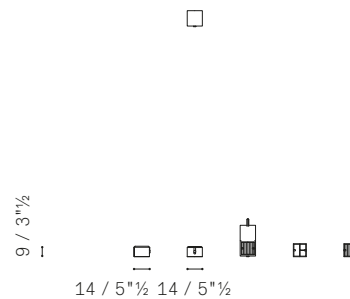



Please note:

this catalogue shows only some technical drawings, in order to know all the availabilities please refer to the current price list.

### Fascination — Leather watch medium box

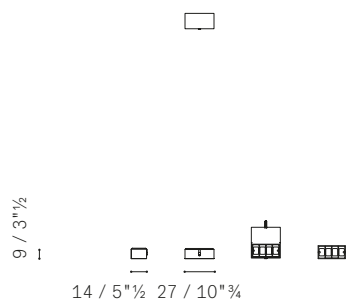

### Fascination — Leather watch small box

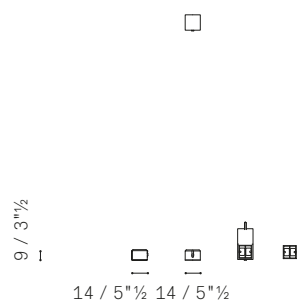

### Fidelio Cabinet — Low Cabinet 180x77

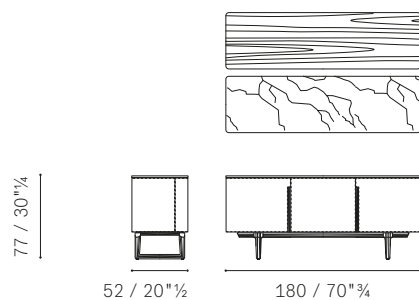

### Fidelio Cabinet — Optional drawer

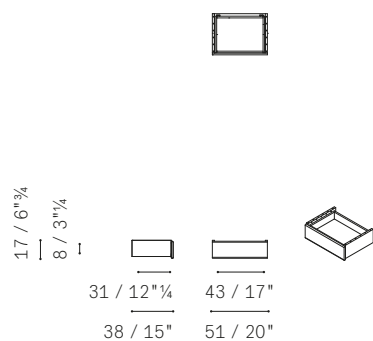

### Fascination — Finishes

#### Models.

- Leather jewelry box
- Leather watch box

#### Size.

- Small
- Medium

#### LEATHER JEWELRY BOX

Upholstery. Externally upholstered in Pelle Frau® ColorSphere® SC 173 Glauco leather, internally in sand coloured micro-fibre.

#### LEATHER WATCH BOX

Upholstery. Externally upholstered in Pelle Frau® ColorSphere® SC 279 Alchemy leather, internally in sand coloured micro-fibre.

### Fidelio Cabinet — Finishes

**Supporting structure.** Made of solid ash wood and birch plywood veneered in ash with a moka finish (61), on the external side, and in natural extra light maple (65) on the inner side.

**Doors structure.** In birch plywood veneered, in the internal side, in moka-stained ash (61).

**Panels edging.** It is made of solid ash moka finish stain (61).

**Top.** Available in the following finishes:

- Ash in a moka stain (61)
- Brilliant Calacatta marble
- Semi-brilliant Calacatta marble
- Brilliant (veined) Arabescato Venato marble
- Semi-brilliant (veined) Arabescato Venato marble
- Brilliant Fior di Pesco Marble
- Semi-brilliant Fior di Pesco Marble

#### Covering.

- Saddle leather
- Saddle Extra leather

#### Stitching.

- Tone-on-tone stitching
- Contrasting stitching

**Back side.** Available in:

- Ash in a moka stain (61)
- Saddle-leather (Saddle or Saddle Extra leather matching with the chosen covering)

## Ikiperu Ceramics — Vase

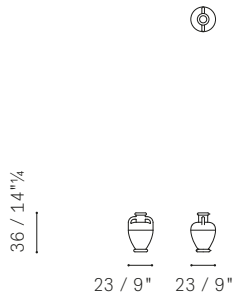

## Ikiperu Ceramics — Pyx

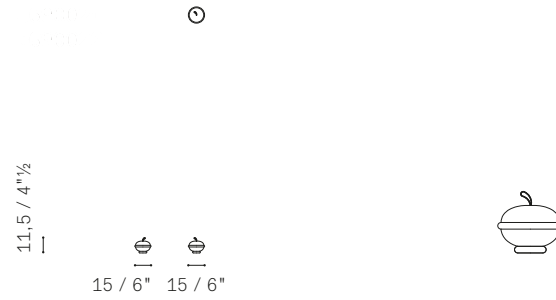

## Ikiperu Ceramics — Cup

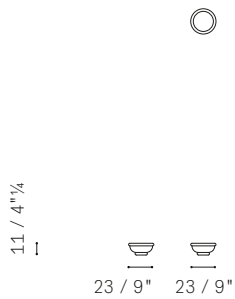

## Ikiperu Ceramics — Finishes

**Material.** All the objects are made of hand thrown and painted pottery. The material combines glossy glazed pottery contrasted with unglazed pottery surfaces.

**Colour combinations.** Two colour combinations are available:

- Sky Blue
- Earth Brown

**Sky Blue.** Features a combination of glazes inspired by the shades of Pelle Frau® ColorSphere®: SC 22 Chiffon, SC 175 Bengali Green, SC 279 Alkemy, SC 67 Chiodi di Garofano

**Earth Brown.** Features a combination of glazes inspired by the shades of Pelle Frau® ColorSphere®: SC 187 Selva, SC 22 Chiffon, SC 146 Coccio Pesto, SC 254 Steel Blue

**Base.** White felt pads are placed on the bottom to protect the surfaces in contact with the objects.

**Aesthetic details.** A camel coloured leather tie facilitates the opening of the pyx's lid.



Please note:

this catalogue shows only some technical drawings, in order to know all the availabilities please refer to the current price list.

### Ikiperu Patchwork Cushions — Cushion

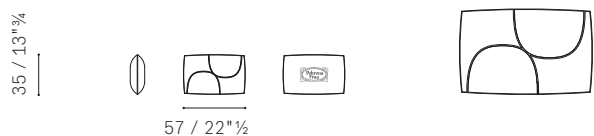

### Ikiperu Patchwork Cushions — Cushion

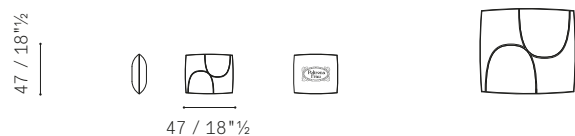

### Infinitemente — Table 340×120

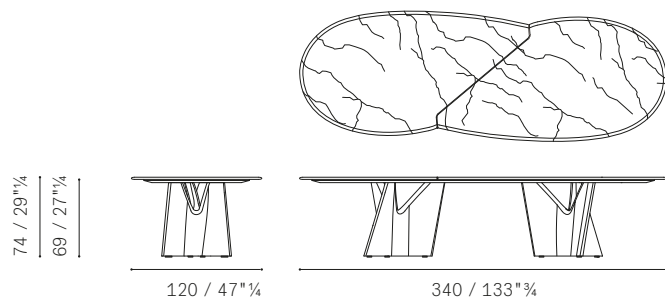

### Infinitemente — Table 220×124

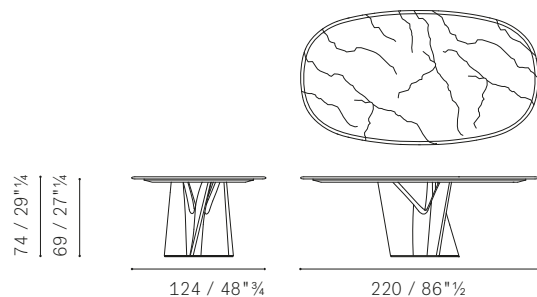

### Ikiperu Patchwork Cushions — Finishes

#### Sizes.

- 47 × 47
- 35 × 57

**Padding.** Goose down protected by an inner cotton and polyester lining.

**Upholstery.** The cushions are upholstered in a combination of different leathers.

**Colour combinations.** Two colour combinations are available:

- Sky Blue
- Earth Brown

**Sky Blue.** Combines the following leathers/colours:

- Velvety Clary Sage
- Velvety Juniper
- Velvety Rosemary
- SC 23 Tortora

**Earth Brown.** Combines the following leathers/colours:

- Velvety Cumin
- Velvety Paprika
- Velvety Sesame
- SC 51 Panna

### Infinitemente — Finishes

#### Models.

- oval table 220×124
- "∞"shaped table 340×120

**Base.** Made from black Marquinia marble.

**Marble top.** Made from glossy White Levigliani marble.

**Aesthetic details.** A polished stainless steel plate with the serial number of the table and the Poltrona Frau logo is applied to the sloping edge of the supporting panel.

**Other details.** Limited edition series.

Oval tables 220×124: 48pieces.

"∞"340×120 tables: 24pieces.

**N.B. Table weight (without packaging).**

Oval table 220×124: 286.5 kg total (no. 1 base: 126 kg; top: 127 kg; supporting panel: 33.5 kg)

"∞"340×120 table: 491 kg total

# L - M

## Le Lampade — Alma table lamp

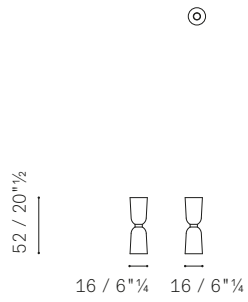

## Le Lampade — Dido table lamp

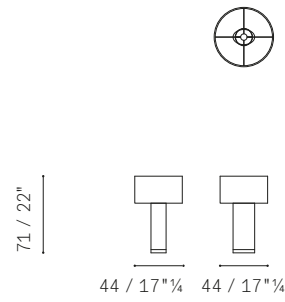

## Le Lampade — Fede floor lamp

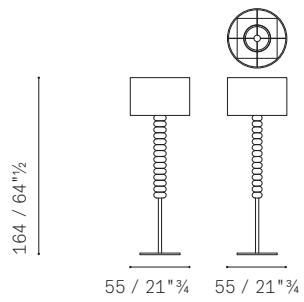

## Le Lampade — Holly floor lamp | single lampshade

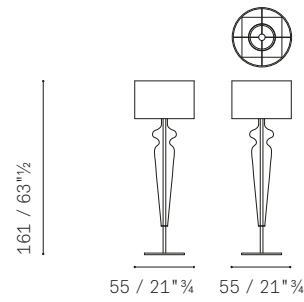

## Le Lampade — Holly floor lamp | double lampshade

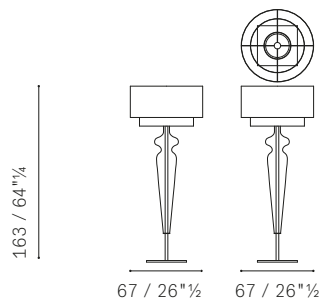

## Le Lampade — Finishes

### Regulations compliance.

- EU/EXTRA EU
- CHINA
- USA
- UKCA

### EU/EXTRA EU Regulation.

- Without accessories
- With UK adapter

### Available lampshade colours.

#### Round lampshade:

- Pearl
- Stone
- Dark blue grey

### Double lampshade (available for Holly only)

- Pearl

## Le Lampade — Holly table lamp

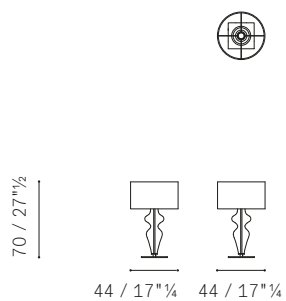



Please note:

this catalogue shows only some technical drawings, in order to know all the availabilities please refer to the current price list.

### Montera Mas — Stool H 67 with metal legs

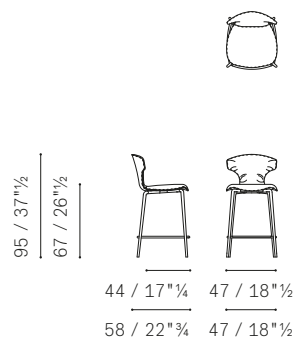

### Montera Mas — Stool H 76 with metal legs

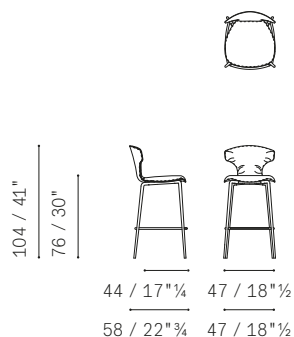

### Montera Mas — Stool H 68 with wood legs

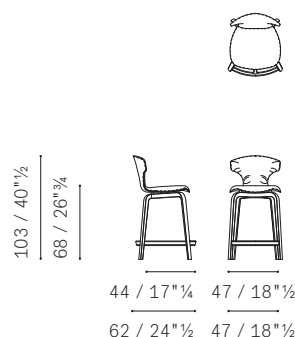

### Montera Mas — Stool H 77 with wood legs

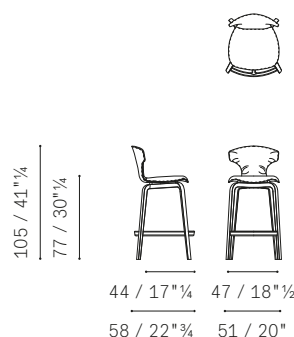

### Montera Mas — Column-base stool

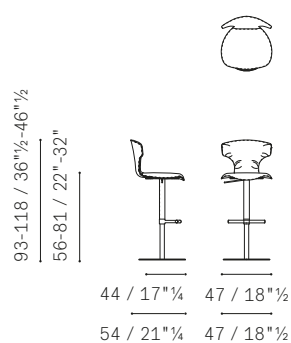

### Montera Mas — Finishes

Upholstery. Pelle Frau® leather or fabric:

- ColorSphere® (SC)
- ColorSphere® (SC) two-tone
- Nest
- Nest two-tone
- Fabric A
- Fabric B
- Fabric C

Removability. Available for both the leather and fabric cover.

#### H 66 AND H 74 STOOLS

Legs. Available in:

- solid ash wood with black nylon spacers
- steel with plastic protective.

Legs finishes.

- Ash in a wenge stain (32)
- Ash in a moka stain (61)
- Burnished painted steel
- Titanium painted steel

#### COLUMN BASE STOOL

Base. Made of chrome plated steel, the base is composed of a four-bracket joint plate structure, a column, a tubular footrest and a fl at round base.

The upper part of the column (above the footrest) is upholstered in leather matching the seat shell upholstery. Felt pads protect the floor.

Functions.

- 1- 360° rotation
- 2- Height-adjusting with gas springs controlled by a chromed steel lever placed under the seat shell.

# T - W

## Trusty — Large dresser caddy

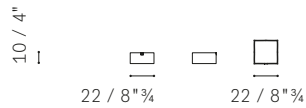

## Trusty — Small dresser caddy

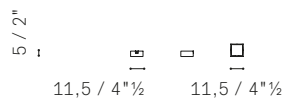

## Trusty — Medium dresser caddy

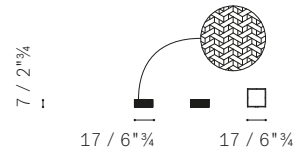

## Trusty — Finishes

### TRUSTY SMALL

Upholstery. Pelle Frau® ColorSphere® leather.

Versions. Available in two colour variants:

- SC 31 Quarzo fumè with raw cut edging in a SC 146 Coccio Pesto
- SC 255 Belladonna with raw cut edging to match

### TRUSTY MEDIUM

Upholstery. Pelle Frau® Motif Weavers, a digitally printed leather with a geometric pattern that recalls the world of weaving.

Versions. Available in two colour variants:

- Sage (Cold colour version, mainly comprised of shades of Green, Brown and Blue.) with raw cut edging in the colour SC 180 Celadon
- Cinnamon (Warm colour version with the more classical hues reminiscent of the world of leather) with raw cut edging in the colour SC 67 Chiodi di Garofano.

### TRUSTY LARGE

Upholstery. Pelle Frau® ColorSphere® leather.

Versions. Available in two colour variants:

- Exterior in SC 136 Ginger Bread / interior and raw cut edging in SC 31 Quarzo Fumè
- Exterior in SC 180 Celadon / interior and raw cut edging in SC 67 Chiodi di Garofano.



Please note:

this catalogue shows only some technical drawings, in order to know all the availabilities please refer to the current price list.

### Weavers Home Fragrance — Candle

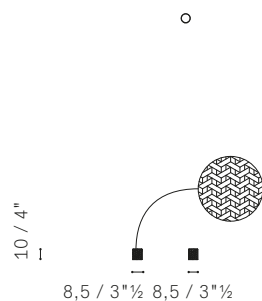

### Weavers Home Fragrance — Diffuser

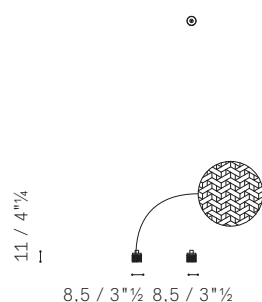

### Weavers Home Fragrance — Finishes

#### Olfactory notes.

Saffron Breeze: head of tuberose, Calabria bergamot, saffron pistil of the Abruzzi, mugwort, to which are added heart of chamois leather, violet, iris, tobacco; background notes include amber, sandalwood, tonka bean, rice powder, heliotropium.

Pink Pepper Touch: head of Neroli, bergamot, sage, Peruvian pink pepper; notes of jasmine heart, nutmeg, leather, tobacco leaves; and finally background notes of amber wood, Bursera graveolens, amyris wood and white cedar.

#### CANDLE

Versions. There are two versions of the cover available depending on the fragrance chosen:

- "Saffron Breeze" fragrance: exterior in Pelle Frau® Motif Weavers Cinnamon leather/ interior lined in Pelle Frau® ColorSphere® SC 66 India leather.
- "Pink Pepper Touch" fragrance: exterior in Pelle Frau® Motif Weavers Sage leather / interior lined in Pelle Frau® ColorSphere® SC 180 Celadon leather.

Lid. Made out of regenerated leather, it protects the candle when not in use and preserves its fragrance. The colour of the leather matches the inner lining of the cover.

#### DIFFUSER

Cover. There are two versions of the cover available depending on the fragrance chosen:

- "Saffron Breeze" fragrance: exterior in Pelle Frau® Motif Weavers Cinnamon leather/ interior lined in Pelle Frau® ColorSphere® SC 67 Chiodi di Garofano leather.
- "Pink Pepper Touch" fragrance: exterior in Pelle Frau® Motif Weavers Sage leather / interior lined in Pelle Frau® ColorSphere® SC 180 Celadon leather.

# Pineider x Poltrona Frau

---

Pineider x Poltrona Frau — A4 Notepad holder

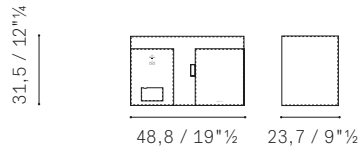

Pineider x Poltrona Frau — Notebook medium

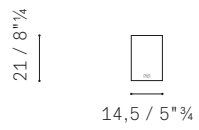

Pineider x Poltrona Frau — Notebook small

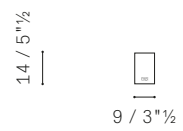

Pineider x Poltrona Frau — Rollerball pen

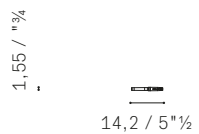



Please note:  
this catalogue shows only some technical drawings, in order  
to know all the availabilities please refer to the current price list.

---

## CONTACTS

### Poltrona Frau S.p.A

a socio unico  
Sede legale in Meda (MB)  
Via Luigi Busnelli 1  
20821 Italy

Sede operativa in Tolentino (MC)  
Via Sandro Pertini 22  
62029 Italy

Tel. +39 0733 909.1  
Fax +39 0733 971600

[www.poltronafrau.com](http://www.poltronafrau.com)

## CREDITS

Graphic design  
**studio FM milano**

Styling  
**Simona Cremascoli**

p 24—43  
painting by **Guido Bisagni (108)**

Lifestyle Photography  
**Alessio D'Aniello | Filippo Maffei**

Still-life Photography  
**Alessio D'Aniello**

Post production / Color selection  
**Pan Group Milano**

Printing  
**OGM Padova**

## © POLTRONA FRAU 2023

Poltrona Frau reserves the right to modify the products and the components in this price list, without any prior notice.  
Company with certified Quality Management System in accordance with ISO 9001, certified Environmental Management System in accordance with ISO 14001, certified Occupational Health and Safety Management System in accordance with BS OHSAS 18001, certified Chain of Custody System in accordance with Forest Stewardship Council® FSC-STD-40-004 (FSC-C153281).

Company subject to management and co-ordination of Haworth Italy Holding S.r.l.





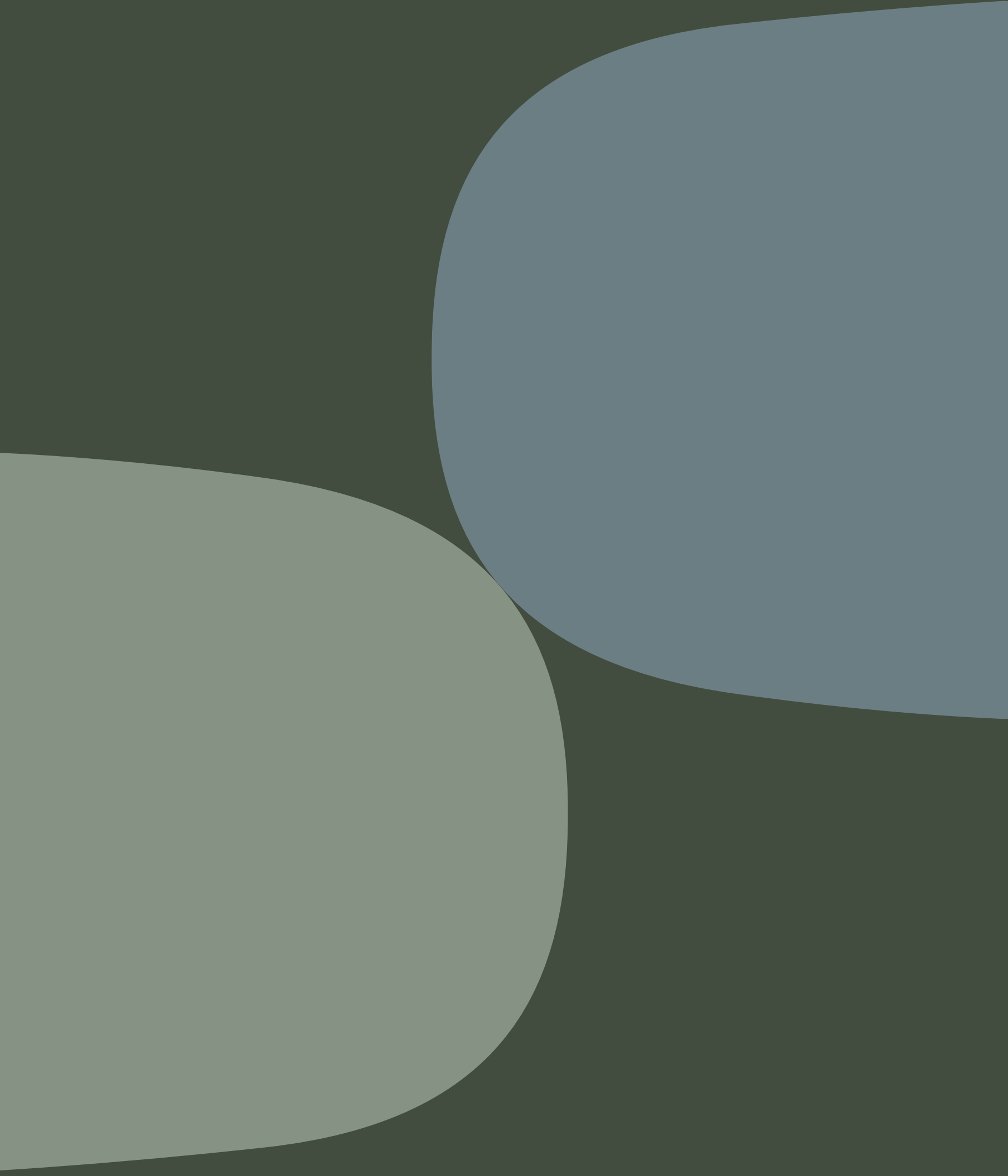

I013653—2500—04/23

Pleasure of Comfortable Living | Pleasure of Writing